

# Other Products

	Page
Lacing Twine	2/103
LOH Lacing	2/103
Hellermann Clips	2/103
PVC Electrical Insulation Tape	2/104
Cable Securing - Slotted and Solid Trunking	2/105
Hellermann Cable Glands	2/106
Utility Junction Box	2/110
Accessories and Nylon / PVC Glands	2/111



## Lacing Twine

### Waxed Nylon Lacing

Hellermann Flat Braided Waxed Nylon Lacing is available in two sizes. Being impregnated with wax, the lacing grips the cables as they are being laced and does not loosen if the tension is reduced. Conforms to MIL - T -43435, type 1, finish B and is suitable for use up to 150°C.

Technical Table

Code	Standard Reel Length (m)	Width nominal (mm)	Thickness* nominal (mm)	Breaking Load minimum (kg)
MW/062	460	1,5	0,3	13,6
MW/090	460	2,3	0,3	22,7

\*Measured under 0,45 kg tension.

### LOH Lacing

A low cost version of the MW waxed nylon lacing is the LOH Series which is available in only one colour (cream).

### PVC Covered Nylon Lacing Cord

PVC Covered Nylon Filled Lacing Cord, ref PNF, is a high grade tubular nylon core covered with a flexible PVC coating. Suitable for use up to 85°C.

Colour: Black only.

### Hellermann Clips

A full range of saddles to fit all main contracting domestic cables sizes. From 3,5 to 12 mm round and flat 4 mm to 12 mm and are available in white, cream, brown and black.

Technical Table

Code	Style	Cable Size	Pin Dimensions Lx Dia. (mm)		Quantity per box
HT350	Round	3,5	15	1,0	100
HT400	Round	4,0	20	1,5	100
HT500	Round	5,0	20	1,5	100
HT600	Round	6,0	20	1,5	100
HT700	Round	7,0	20	1,5	100
HT800	Round	8,0	29	2,0	100
HT900	Round	9,0	29	2,0	100
HT1000	Round	10,0	29	2,0	100
HT1100	Round	11,0	29	2,0	100
HT1200	Round	12,0	29	2,0	100
HT40	Flat	4,0	15	1,0	100
HT50	Flat	5,0	15	1,5	100
HT90	Flat	9,0	29	2,0	100
HT100	Flat	10,0	29	2,0	100
HT120	Flat	12,0	29	2,0	100



Waxed Nylon Lacing



LOH Lacing

Technical Table

Code	Length (m)	Diameter (mm)
LOH 1	1000	1,7
LOH 2	1000	2,0

Technical Table

Code	Nominal Diameter (mm)	Colour	Standard Reel Lengths (m)
PNF 1012	1,1	Black	760

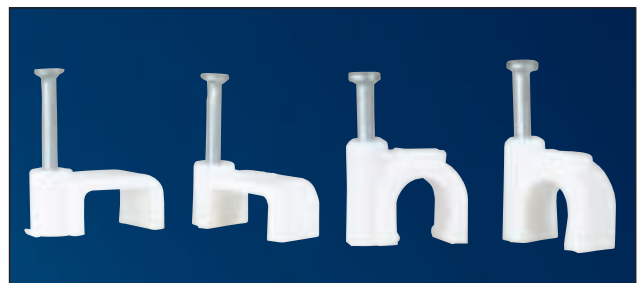

Cable Clips

## PVC Electrical Insulation Tape

Self adhesive PVC tapes are made of non-rigid polyvinyl chloride, are accepted as a best quality general use vinyl tape and widely used in wiring works. They provide excellent electrical insulation and adhesion. Another plus is the tapes' high resistance to temperature extremes.

### Hellertape

HT1 and HT2 - are both a cold and weather resistant electrical tape, coated with an aggressive rubber resin adhesive with good ageing characteristics. Extremely flexible, even in cold weather and unaffected by moisture and most chemicals. No flagging or deterioration even under temperature as high as 80°C.

Technical Table

Description	PVC Electrical Insulation Tape				
	HT2\$	HT3\$	HT4LF	HT4BK	HT4FR9B1
Thickness (mm)	0.18	0.13	0.13	0.13	0.13
Length (m)	20	10	20	20	10
Width (mm)	18	19	19	19	9
Adhesion (N/cm)	1.8	1.6	1.5	1.6	1.6
Tensile strength (N/cm)	26	17	20	17	17
Elongation (%)	200	160	160	160	160
Breakdown Voltage (kv)	8.0	5.5	6.0	5.5	5.5
Temperature (°C)	-10 to + 80	-10 to + 80	-10 to + 80	-10 to + 80	-10 to + 80

\$ = Colour

- HT2/HT3 – Black, Red, Green, White, Yellow, Blue
- HT4 – Black

### Nitto (No. 21)

A21\$208 - Is a cold and weather resistant electrical tape, coated with an aggressive rubber resin adhesive with good ageing characteristics. Extremely flexible, even in cold weather and unaffected by moisture and most chemicals. No flagging or deterioration even under temperatures from -18 to 80°C.

Technical Table

Description	PVC Electrical Insulation Tape
	A21\$208
Thickness (mm)	0.2
Length (m)	20
Adhesion (kg/1")	410
Tensile strength (kg/1")	9.5
Elongation (%)	200
Breakdown voltage (kv)	9
Insulation Class (°C)	9.0

\$ = Colour – Black, Red, Green, White, Yellow, Blue



## Cable Securing

### Slotted Trunking

- Grey RAL700 PVC material
- Self-extinguishing hard PVC
- Length 2 m
- Available in a range of sizes

Technical Table

Code		Size W x H (mm)	Std. Pack (Lengths)
20 mm	10 mm		
1525C		15 x 25	50
2525C		25 x 25	75
1530C	1530N	15 x 30	50
3030C	3030N	30 x 30	60
2540C	2540N	25 x 40	50
4040C	4040N	40 x 40	36
6040C	8040N	60 x 40	24
8040C	8040N	80 x 40	30
2560C	2560N	25 x 60	32
4060C	4060N	40 x 60	24
6060C	6060N	60 x 60	16
8060C	8060N	80 x 60	24
10060C	10060N	100 x 60	16
2580C	2580N	25 x 80	42
4080C	4080N	40 x 80	30
6080C	6080N	60 x 80	24
8080C	8080N	80 x 80	18
10080C	10080N	100 x 80	12
12080C	12080N	120 x 80	12
80100C		80 x 100	12
100100C		100 x 100	18
150100C		150 x 100	12

\* C Donates Wide Slot 20 mm

\* N Donates Narrow Slot 10 mm

### Solid Trunking

- White PVC material
- Snap on lids included
- Available in a range of sizes
- Available with adhesive backing
- RCC No. 0608092

Technical Table

Without Adhesive Tape				
Code	Std Pack Size	Std Pack (Lengths)	Thickness (mm)	Length (m)
1616S	16 x 16	25	0.9	2
2516S	25 x 16	25	1.0	2.9
2525S	25 x 25	15	1.0	2.9
4016S	40 x 16	15	0.9	2.9
4025S	40 x 25	12	1.0	2.9
4040S	40 x 40	9	1.2	2.9
10040S	100 x 40	2	2.0	2.9

With Adhesive Tape Backing				
Code	Std Pack Size	Std Pack (Lengths)	Thickness (mm)	Length (m)
1616SA	16 x 16	25	0.9	2
2516SA	25 x 16	25	1.0	2.9
2525SA	25 x 25	15	1.0	2.9
4016SA	40 x 16	15	0.9	2.9
4025SA	40 x 25	12	1.0	2.9
4040SA	40 x 40	9	1.2	2.9

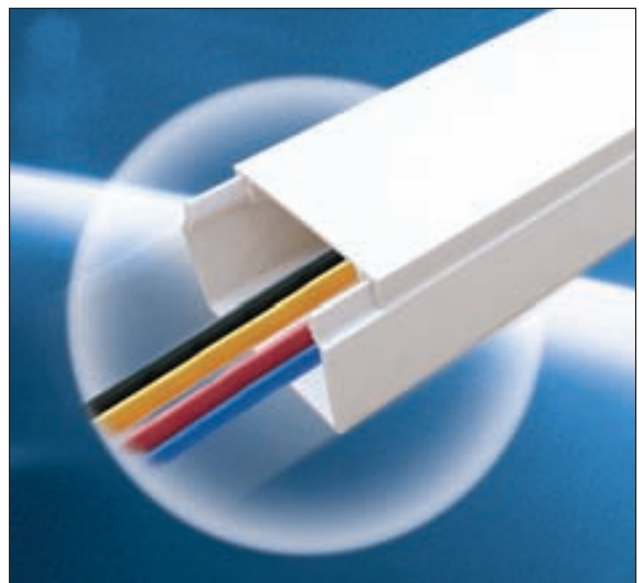
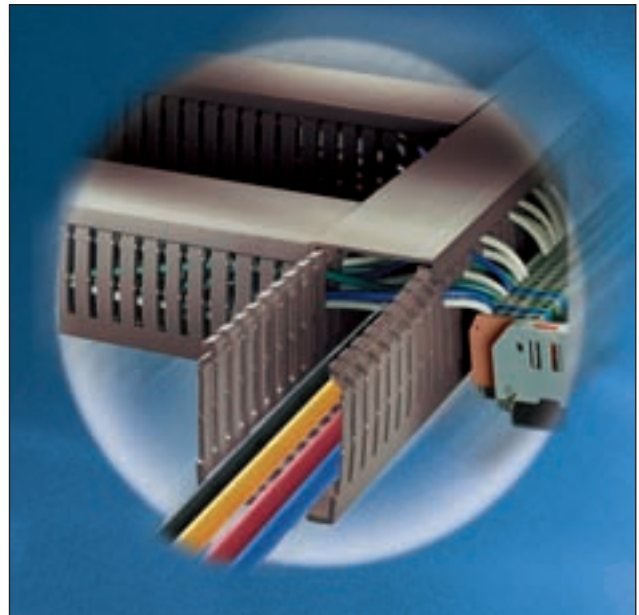

## Cable Glands

### Cable Acceptance Range

Technical Table

Gland Size	Entry (mm)	Standard Cable Glands		A2 Compression Glands	
		Max Bedding Diameter (mm)	Max Cable Diameter (mm)	Min Cable Diameter (mm)	Max Cable Diameter (mm)
00	20			3.0	8.0
0	20	12.5	14.8	7.0	12.0
1	20	15.7	18.7	12.0	16.0
2	25	20.6	24.4	16.0	21.0
3	32	26.5	30.0	21.0	27.0
4	40	35.0	39.5	27.0	36.0
5	50	44.0	49.0	36.0	45.0
6	63	56.0	62.2	45.0	57.0
7	75	68.0	74.0	57.0	69.0
8	82	74.0	81.0		

All dimensions in mm. Subject to technical changes. Gland Size 8 is only available in BWLE

### Gland Selection Guide

(For PVC, PVSC SWA Cables SABS 1507 600-1000V)

Technical Table

Gland Size	Recommended Gland Size For Cable Size/Number Of Cores																	
	Number of Cores																	
	2	3	4	5	6	7	8	10	12	14	15	19	20	21	24	27	30	37
mm <sup>2</sup>	2	3	4	5	6	7	8	10	12	14	15	19	20	21	24	27	30	37
1.5	0	0	0	0/1	1	1	1	2	2	2	2	3	3	3	3	3	3	4
2.5	0	0	0/1	1	2	2	2	2	3	3	3	3	3	3	4	4	4	4
4.0	0/1	1	1	1/2	2	2	2	3	3	3	3	4	4	4	4	4	4/5	5
6.0	1	1	1/2	2	2	2												
10.0	1/2	2	2															
16.0	2	2	3															
25.0	2/3	2/3	3															
35.0	2/3	3	3/4															
50.0	3	3/4	4															
70.0	3/4	4	4/5															
95.0	4	4/5	5															
120.0	4	5	5															
150.0	4/5	5	5/6															
185.0	5	5/6	6															
240.0	6	6	6/7															
300.0	6	6	7															
**	8																	

All dimensions in mm. Subject to technical changes.

\*\* Check the bedding diameter of the cable.

### Please Note

Owing to the varying dimensions of cable manufactured by different cable manufacturers, we cannot guarantee the above chart to be accurate for every make of cable. Two integers appearing in one square '1/2' indicates that the cable size is borderline and either gland size shown may be used.



### BWR Rotary Cone Glands

Nickel-plated brass gland for use with all types of SWA cable. To provide clamping of the armour wire for earth continuity and mechanical retention of the cable. May be used both indoors and outdoors.

#### Benefits

- Easy to install (rotary cone)
- Protects armour wire

#### Sizes

- 0-7

#### Features

- Rotary cone
- High quality nickel plating

#### Accessories

- PVC or rubber shrouds
- Earth Tags

#### Approvals

- SABS1213 approval
- Test report available on request



### BWL Loose Cone Glands

Nickel-plated brass gland for use with all types of SWA cable. To provide clamping of the armour wire for earth continuity and mechanical retention of the cable. May be used both indoors and outdoors.

#### Benefits

- Easy to install (loose cone)
- Protects armour wire

#### Sizes

- 0-7

#### Features

- Loose cone
- High quality nickel plating

#### Accessories

- PVC or rubber shrouds
- Earth tags

#### Approvals

- SABS1213 approval
- Test report available on request



### BWLE Loose Cone Glands (Economy)

Nickel-plated brass gland for use with all types of SWA cable. To provide clamping of the armour wire for earth continuity and mechanical retention of the cable. May be used both indoors and outdoors.

#### Benefits

- Easy to install (loose cone)
- Protects armour wire
- Low cost

#### Sizes

- 0-8

#### Features

- Loose cone
- High quality nickel plating

#### Accessories

- PVC or rubber shrouds
- Earth tags

#### Approvals

- SABS1213 approval
- Test report available on request



### A2 Compression Glands

Nickel-plated brass gland for use with all types of 'unarmoured' cable. May be used both indoors and outdoors.

#### Benefits

- Easy to install
- Displacement seal concept ensures effective seal to the outer sheath.

#### Sizes

- 0-7

#### Features

- Novel seal design accommodates wide cable range
- High quality Nickel pLATiNg

#### Approvals

- SABS1213 approval
- Test report available on request

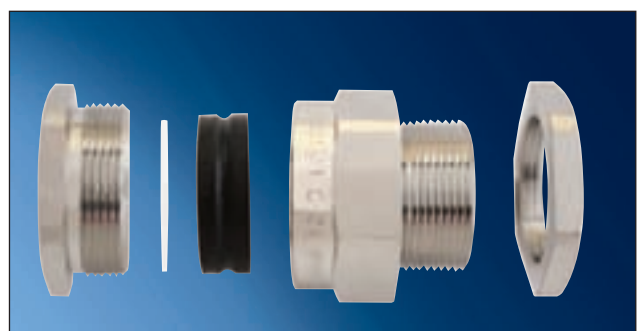

### BWR Exe Rotary Cone Glands

Nickel-plated brass gland for use with all types of SWA cable in hazardous areas. To provide clamping of the armour wire for earth continuity and mechanical retention of the cable. May be used both indoors and outdoors.

#### Benefits

- Easy to install (rotary cone)
- Protects armour wire
- IP68 rated

#### Sizes

- 0-7

#### Features

- Rotary cone
- High quality nickel plating

#### Accessories

- PVC or rubber shrouds
- Earth tags

#### Approvals

- SANS 60079  
Part 0: 2005  
Part 7: 2003
- Test report available on request

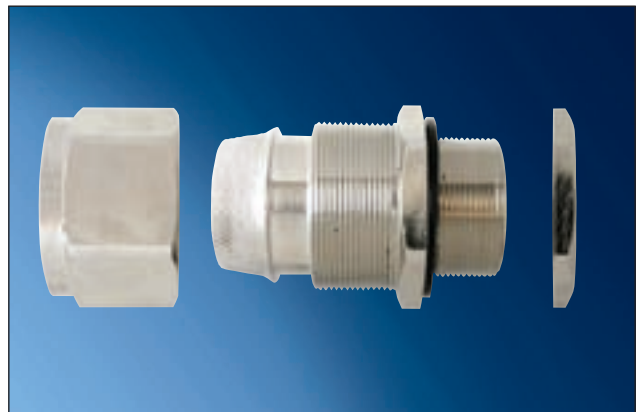

### A2 Exe Compression Glands

Nickel-plated brass gland for use with all types of 'unarmoured' cable in hazardous areas. May be used both indoors and outdoors.

#### Benefits

- Easy to install
- Displacement seal concept ensures effective seal to the outer sheath.
- IP68 rated

#### Sizes

- 0-7

#### Features

- Novel seal design accommodates wide cable range
- High quality nickel plating

#### Approvals

- SANS 60079  
Part 0: 2005  
Part 7: 2003
- Test report available on request

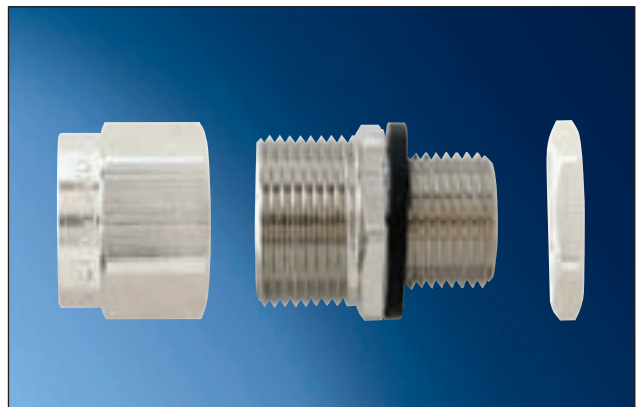

## Utility Junction Box

### Features

- Manufactured from high impact, corrosion and UV resistant material
- For use in general and industrial installations
- SABS 1222 IP66/68. (Dust and water tight)
- Allows for 1, 2, 3 and 4 way connections
- Blanking plugs, O-rings and lock nuts provided
- No need for drilling and tapping
- Internal earth plate provided (no exposed metal parts)
- Din rail mounting studs provided
- UJB1/2T - Special locking key to prevent unauthorised entry (optional)
- UBJ1/2C - UJB1 with clear lid

### Certifications

- SABS 1222 IP66/68
- IEC529
- UJB1EX / UJB2EX - IEC 60529, SANS 60529, SANS 60079 - 0/7, SANS 60079 - 15, SANS 61241-1-1, IP66/68, IP68 (2 m cont), Ex e II T6, Ex Na II T6, DIP B21 Tb T6

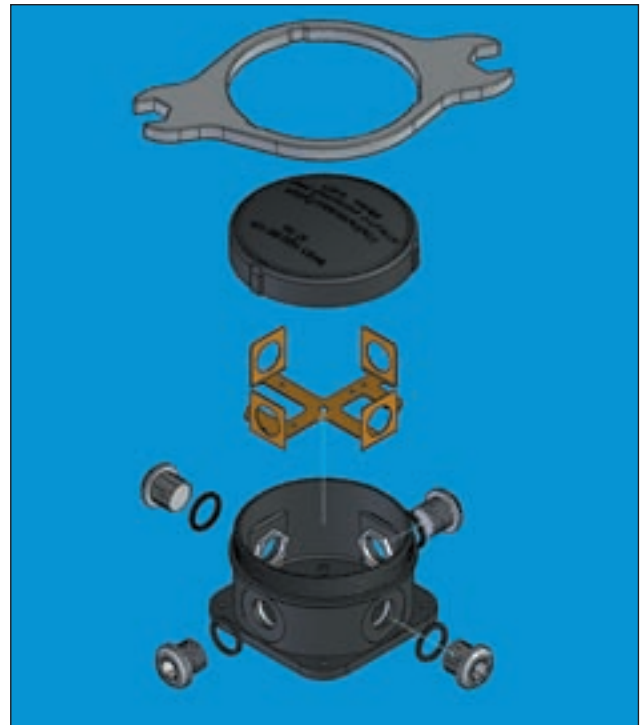

## Selection Chart

Technical Table

Code	Dimensions (mm)							
	Total Width(A)	Outside Height(B)	Inside Height(C)	Gland Size(D)	Inside Width(E)	Fixing Hole		
						(F)	(G)	(H)
UJB1	109	75	57	M20	94	122	96	6.9
UJB2	135	85.5	59.5	M25	124	150	106	7
UJB1EX	109	75	57	M20	94	122	96	6.9
UJB2EX	135	85.5	59.5	M25	124	150	106	7

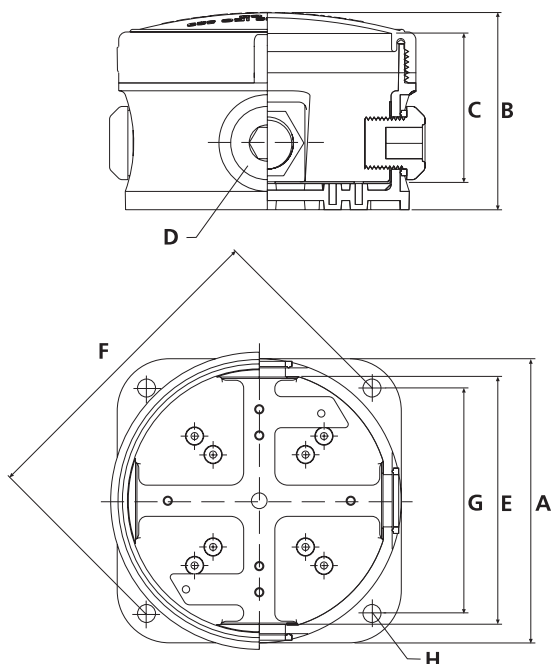

## Accessories

### Shrouds

Technical Table

PVC Shrouds		Rubber Shrouds	
Code	Size	Code	Size
SHPL0	0	SHRL0	0
SHPL1	1	SHRL1	1
SHPL2	2	SHRL2	2
SHPL3	3	SHRL3	3
SHPL4	4	SHRL4	4
SHPL5	5	SHRL5	5
SHPL6	6	SHRL6	6
SHPL7	7	SHRL7	7

### Earth Tags-

Technical Table

Slip-on Earth Tag			
Code	Slip-size	Ø A (mm)	Ø B (mm)
ET0	0	20	6.8
ET1	1	20	6.8
ET2	2	25	6.8
ET3	3	32	6.8
ET4	4	40	6.8
ET5	5	50	10.5
ET6	6	63	10.5
ET7	7	75	10.5

## Metric ABS & Glass Filled Nylon Glands

### Features

- Multipurpose application
- Water tight
- Easy to assemble
- Good strain relief
- Wide clamp range
- Multiple interlock facets-guarantee equal compression against cable
- Advanced thread design improves cap/cable compression
- Metric thread, 20 x 1.5 mm.

Technical Table

Code	Colour	Material	Clamping Range (mm) diam.	Thread Length (mm)
AGN001GY*	Grey	Glass Filled Nylon	6.5 to 12.5	11.5
AS001BK	Black	ABS	6.5 to 12.5	11.5
AS001WT	White	ABS	6.5 to 12.5	11.5
BCS1WT	White	ABS	10 to 12.5	13
BS0WT	White	ABS	8.5 to 10.5	13
BS1WT	White	ABS	10 to 12.5	13
BS0BK	Black	ABS	8.5 to 10.5	13
BS1BK	Black	ABS	10 to 12.5	13

### Notes:

- \* Glass-filled Nylon Glands have limited UV resistance

