

# Special Purpose Fixings

TY Plastic Rivets

CTC Convolved Tubing Clamps

Pipe and Hose Clips - PC Series

SBH, SBF and CTMS Cable Tie Base for Weld Studs

Automatic Harness Clips

Pipe and Hose Clips - IPC Series

Page

2/86

2/87

2/88

2/89

2/90

2/91



## TY Plastic Rivets

### Features and Benefits

Moulded in one piece and simply applied by pushing the pin into the body of the rivet. Two types are available the TY3PI, TY8PI, pins are inserted by means of a rivet placement tool whilst the TY8P2 types have a 'mushroom' head which allows the pin to be simply hammered in.

### Application

These simple to use plastic rivets are ideal for improving productivity in the working environment, saving time and money over more conventional jointing methods. Ideal for joining panels, or components to panels in a wide range of industries from 'automotive' to 'panel building'.



Plastic Rivets TY8P1.

#### Material Data

RoHS	Material	Polyamide 6.6 (PA66)	HF (halogenfree)
	Operating Temperature	-40°C to +85°C Continuous, (+105°C for 500 h)	
	Flammability	UL94 V2	

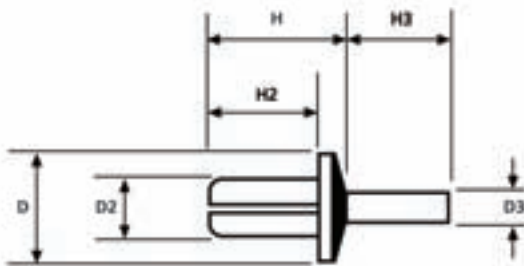

Plastic Rivets TY3P1/8P1

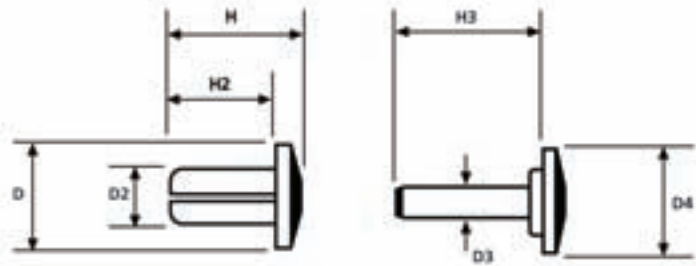

Plastic Rivets TY8P2

#### Technical Table

Code	Height (H)	Height (H2)	Height (H3)	Ø D	Ø D2	Ø D3	Ø D4	Material	Colour
TY3P1	7.5	6.0	5.3	6.0	3.0	1.7	–	PA66	Black (BK)
TY3P1	7.5	6.0	5.3	6.0	3.0	1.7	–	PA66	Natural (NT)
TY8P1	10.0	8.0	7.5	8.0	4.0	2.6	–	PA66	Black (BK)
TY8P1	10.0	8.0	7.5	8.0	4.0	2.6	–	PA66	Natural (NT)
TY8P2*	10.0	8.0	11.5	8.0	4.0	2.6	8.0	PA66	Black (BK)
TY8P2*	10.0	8.0	11.5	8.0	4.0	2.6	8.0	PA66	Natural (NT)

All dimensions in mm. Subject to technical changes.

\*TY8P2 consist of two unattached parts.

## CTC Convoluted Tubing Clamp

### Features and Benefits

The clamps for corrugated tubing are available in various nominal diameters and have a base in the shape of a fir tree for inserting in a drilled hole. Due to the individual fins, the clamp can be inserted into blind holes with threading. The corrugated tubing is snapped into the clamp where it is securely held. The rib on the inside of the bracket fits into the profile of the tubing and prevents the tubing from slipping.

### Application

CTC clamps are used for example in the automobile, harness making, electrical industry and wherever corrugated tubing has to be quickly and firmly fixed.



The tubing is clicked into the CTC clamp and is held firmly.

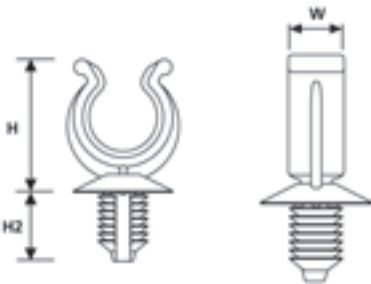

CTC10FT6LG

### Material Data

RoHS	Material	Polyamide 6.6 High Impact Modified, Heat Stabilised (PA66HIRHS)
	Colour	Black (BK)
	Operating Temperature	-40°C to +105°C
	Flammability	UL94 HB

### Technical Table

Code	Width (W)	Height (H)	Height (H2)	Normal Ø	Disc Ø	Fixing Hole Ø (FH)	Panel Thickness min.	Panel Thickness max.	For Convoluted Tubing
CTC4.5FT6LG	8.0	16.1	11.1	4.5	16.0	6.5-7.0	0.75	6.0	IWS 4,5
CTC7.5FT6LG	8.0	18.6	11.1	7.5	16.0	6.5-7.0	0.75	6.0	IWS 7,5-8,5
CTC7.5FT9	8.0	19.9	12.2	7.5	23.0	8.7-9.0	3.0	5.0	IWS 7,5-8,5
CTC10FT6	8.0	21.4	7.5	10.0	16.0	6.5-7.0	0.75	3.0	IWS 8,5-13
CTC10FT6LG	8.0	21.4	11.1	10.0	16.0	6.5-7.0	0.75	6.0	IWS 8,5-13
CTC10FT9	8.0	22.7	12.2	10.0	23.0	8.7-9.0	3.0	5.0	IWS 8,5-13
CTC13FT6	8.0	25.2	7.5	13.0	16.0	6.5-7.0	0.75	3.0	IWS 10-17
CTC13FT6LG	8.0	25.2	11.1	13.0	16.0	6.5-7.0	0.75	6.0	IWS 10-17
CTC22FT9	8.0	37.7	12.2	22.0	23.0	8.7-9.0	3.0	5.0	IWS 19-29

All dimensions in mm. Subject to technical changes.

## Pipe and Hose Clips - PC Series

### Features and Benefits

These clips can be attached to the panel prior to installing the pipe or hose, simply push the pipe into the clip for a firm and secure fixing.

### Application

Originally designed for the automotive industry they are finding a wide and time saving variety of applications in all industries and where the use of a cable is not possible.

#### Material Data

<b>RoHS</b>	Material	Polyamide 6.6 (PA66)
	Operating Temperature	-40°C to +85°C Continuous, (+105°C for 500 h)
	Flammability	UL94 V2
	<b>HF</b> (halogenfree)	

#### Material Data

<b>RoHS</b>	Material	Polyamide 4.6 (PA46)
	Operating Temperature	-40°C to +150°C for 5000 h, (+195°C for 500 h)
	Flammability	UL94 V2
	<b>LFH</b> (Limited Fire Hazard)	



Simple and secure installation of pipes or hoses to panels.

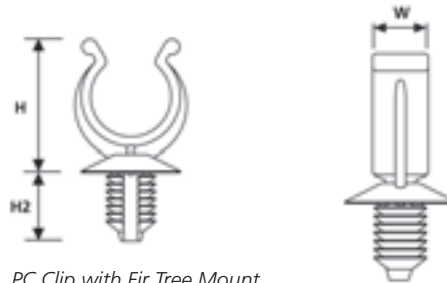

PC Clip with Fir Tree Mount

#### Technical Table

Code	Width (W)	Height (H)	Height (H2)	Disc Ø	Bundle Ø max.	Fixing Hole Ø max.	Panel Thickness min.	Panel Thickness max.	Material	Colour	Drawing
PC35LAH	8.0	10.5	5.0	–	3.5	4.7	0.8	2.0	PA66	Black (BK)	
PC5LAH	8.0	12.0	5.9	–	5.0	5.4	0.65	1.5	PA66	Black (BK)	
PC14AH	10.0	20.6	8.8	22.0	14.2	6.15-6.45	2.7	3.3	PA66	Grey (GY)	
PC23	10.0	36.0	6.5	22.0	24.0	6.3	0.6	1.6	PA66	Natural (NA)	
PC5DP7S	–	9.5	8.1	16.0	5.0	7.0	0.8	3.0	PA66	Black (BK)	
PC5DP7L	–	9.5	12.6	16.0	5.0	7.0	0.8	7.0	PA46	Black (BK)	
PC14PT	10.0	20.6	7.6	22.0	14.2	6.15-6.45	2.7	3.3	PA66	Black (BK)	

All dimensions in mm. Subject to technical changes.

## SBH, SBF and CTMS Cable Tie Base for Weld Studs

### Features and Benefits

When used with a cable tie and simply hammered onto the stud the SBH type offer a simple and quick method of fixing. The SBH1 and 3 as well as the CTMS5 allow the cables to run across the panel whilst the SBH2 allows the cable to run at 90° to the panel.

### Application

Many industries (but specifically the automotive market) are using 'weld studs' as the standard method of attaching components. Simply hammered onto the stud these parts provide ideal fixing bases for attaching cables, pipes or hoses. The use of weld studs avoids the problems with 'holes' (ingress of moisture, corrosion etc.)

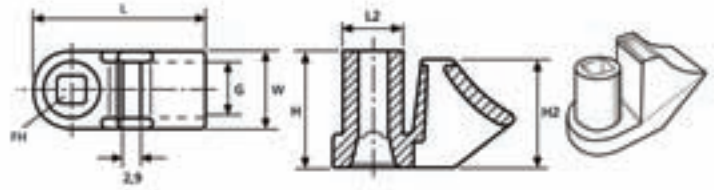

Cable tie base SBH1,3

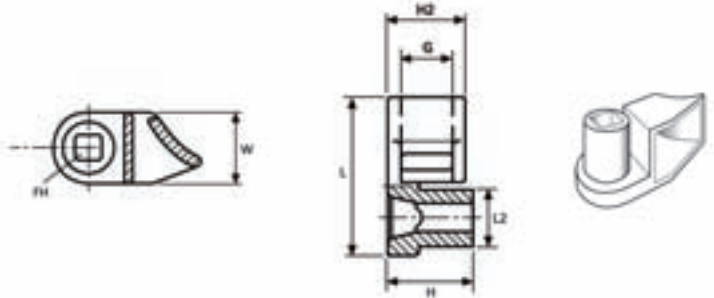

Cable tie base SBH2

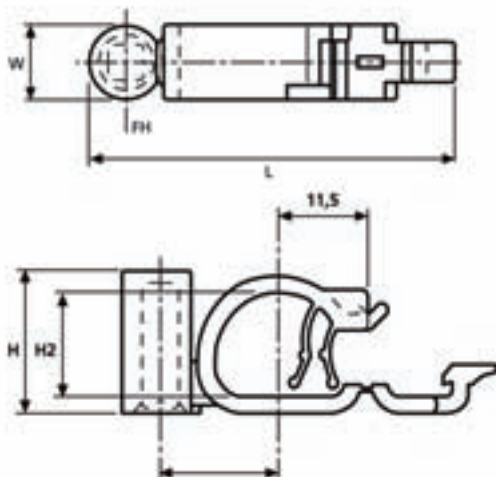

Cable tie base SBF2

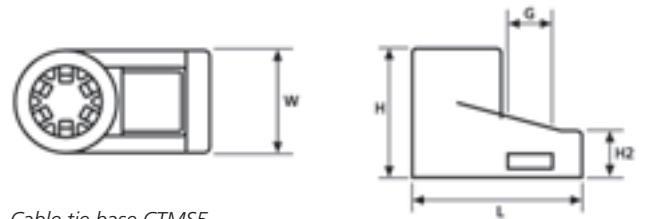

Cable tie base CTMS5

### Material Data

RoHS	Material	Polyamide 6.6 (PA66)
	Colour	Black (BK)
	Operating Temperature	-40°C to +85°C Continuous, (+105°C for 500 h)
	Flammability	UL94 V2



(halogenfree)

### Technical Table

Code	Length (L)	Length (2)	Width (W)	Height (H)	Height (H2)	Stud Ø	Bundle Ø max.	Strap Width max. (G)
SBH1	26.8	9.0	12.5	13.9	15.9	5.0	–	8.5
SBH2	26.8	9.0	12.5	14.0	12.5	5.0	–	8.5
SBH3	26.8	9.0	12.5	18.0	15.9	5.0	–	8.5
SBF2	47.7	–	10.0	18.2	13.5	5.0	13.5	–
CTMS5	19.0	–	10.0	14.5	5.3	5.0	–	5.0

All dimensions in mm. Subject to technical changes.

## Automatic Harness Clips

### Features and Benefits

These clips can be attached to the panel prior to installing the cables, simply pushing the cable into place, closes the clip which activates the automatic locking feature. The parts prefixed with an 'I' can be interlocked giving a greater choice of installation options.

### Application

Offering a simple and secure method of attaching cables to panels. Originally designed for the automotive industry they are finding a wide variety of applications in all industries using sheet metal panels.

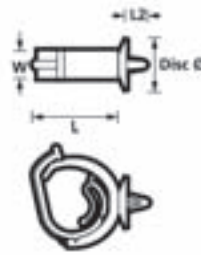

AHC 1AH - 2AH



AHC2 SS

Technical Table

Code	Length (L)	Length (L2)	Width (W)	Disc Ø	Bundle Ø max.	Fixing Hole Ø (FH)	Panel Thickness min.	Panel Thickness max.	Material Shortcut	Colour
AHC1AH	25.0	7.0	10.0	20.0	13.0	6.2-6.7	0.5	2.0	PA66	Black (BK)
AHC2AH	29.5	7.0	10.0	20.0	20.0	6.2-6.7	0.5	2.0	PA66	Black (BK)
AHC2SS	31.5	–	10.0	–	20.0	–	–	–	PA66	Black (BK)
<b>Connectable</b>										
IAHC3AH	39.0	7.0	10.0	24.0	28.0	6.2-6.7	0.5	2.7	PA66	Black (BK)
IAHC4AH	46.0	7.0	13.0	24.0	36.0	6.2-6.7	0.5	2.5	PA66	Black (BK)
IAHC1T	23.0	–	10.0	–	13.0	–	–	–	PA66	Black (BK)
IAHC2T	30.0	–	10.0	–	20.0	–	–	–	PA66	Black (BK)
IAHC3T	40.0	–	10.0	–	28.0	–	–	–	PA66	Black (BK)
IAHC4T	47.0	–	13.5	–	36.0	–	–	–	PA66	Black (BK)
IAHC5T	57.0	–	13.5	–	45.0	–	–	–	PA66	Black (BK)

All dimensions in mm. Subject to technical changes.

Material Data

Material	Polyamide 6.6 (PA66)
Colour	Black (BK)
Operating Temperature	-40°C to +85°C Continuous, (+105°C for 500 h)
Flammability	UL94 V2

RoHS

HF  
(halogenfree)

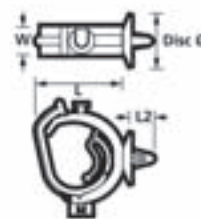

AH



T



Elements AH and T connected

## Pipe and Hose Clips, PC Series

### Features and Benefits

These clips can be attached to the panel prior to installing the pipe or hose, simply push the pipe into the clip for a firm and secure fixing. The parts prefixed with an 'I' can be interlocked giving a greater choice of installation options.

### Application

Originally designed for the automotive industry they are finding a wide and time saving variety of applications in all industries where the use of a cable is not possible.



Simple and secure installation of pipes or hoses to panels.

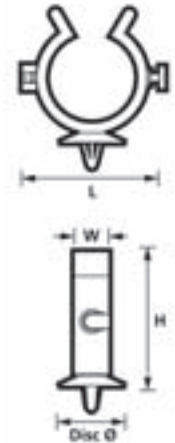

IPC AH Clip

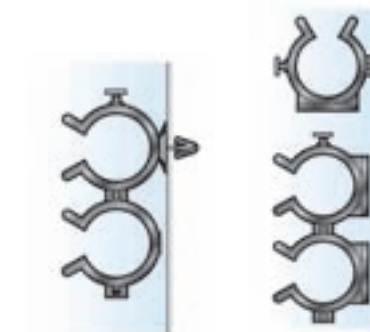

IPC AH Clip connected.

IPC P Clip connected.

#### Material Data

RoHS	Material	Polyamide 6.6 High Impact Modified (PA66HIR)
	Operating Temperature	-40°C to +80°C Continuous, (+105°C for 500 h)
	Flammability	UL94 HB

#### Technical Table

Code	Height (H)	Width (W)	Disc Ø	Bundle Ø max.	Fixing Hole Ø (FH)	Panel Thickness max.	Material Shortcut	Colour
<b>Connectable Arrowhead</b>								
IPC10AH	18.4	10.0	22.0	12.5	6.3	1.6	PA66HIR	Black (BK)
IPC13AH	21.0	10.0	22.0	13.5	6.3	1.6	PA66	Black (BK)
IPC15AH	23.0	10.0	22.0	14.7	6.3	1.6	PA66HIR	Black (BK)
IPC23AH	34.0	10.0	22.0	25.0	6.3	1.6	PA66	Black (BK)
<b>Connectable</b>								
IPC10P	15.0	10.0	–	12.5	–	–	PA66HIR	Black (BK)
IPC13P	17.4	10.0	–	13.5	–	–	PA66	Black (BK)
IPC15P	19.5	10.0	–	14.7	–	–	PA66HIR	Black (BK)
IPC23P	30.5	10.0	–	25.0	–	–	PA66	Black (BK)

All dimensions in mm. Subject to technical changes.

#### Material Data

RoHS	Material	Polyamide 6.6 (PA66)
	Operating Temperature	-40°C to +85°C Continuous, (+105°C for 500 h)
	Flammability	UL94 V2

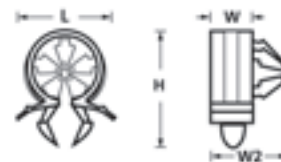

OHC Clip

#### Technical Table

Code	Height (H)	Length (L)	Width (W)	Width (W2)	Bundle Ø min.	Bundle Ø max.	Material Shortcut	Colour
OHC8	20.7	12.5	8	12.5	2	8	PA66	Black (BK)
OHC16	29.5	23.5	8	16	6	16	PA66	Black (BK)

All dimensions in mm. Subject to technical changes.