









# GSC53N - GSC57 - ZG47

**Instruction Manual**





**INDEX**

<b>1. SAFETY PRECAUTIONS AND PROCEDURES .....</b>	<b>4</b>
1.1. GENERAL.....	4
1.2. Preliminary Instruction .....	4
1.3. During Use.....	5
1.4. After Use.....	5
<b>2. GENERAL DESCRIPTION .....</b>	<b>6</b>
2.1. Introduction .....	6
2.2. Functions .....	6
<b>3. PREPARATION FOR USE .....</b>	<b>8</b>
3.1. Initial Control.....	8
3.2. Power Supply.....	8
3.3. Calibration.....	9
3.4. Storage .....	9
<b>4. INSTRUMENT DESCRIPTION .....</b>	<b>10</b>
4.1. Display Description .....	11
4.2. Initial Screen .....	11
4.3. Backlight function.....	11
<b>5. INITIAL SETTINGS.....</b>	<b>12</b>
5.1. How to Adjust the Contrast .....	12
5.2. How to Set Date and Time.....	12
5.3. How to Set the Language .....	12
5.4. Reset .....	13
<b>6. SAFETY TEST FUNCTIONS .....</b>	<b>14</b>
6.1. LOW $\Omega$ : Continuity Test with 200mA Test Current.....	14
6.1.1. Calibrating the test leads ("CAL" Mode) .....	15
6.1.1.1. Procedure to reset test leads' calibration parameters.....	16
6.1.2. Measurement Procedure .....	17
6.1.3. Results of "AUTO" mode .....	18
6.1.4. Results of "RT+" and "RT-" modes.....	18
6.1.5. "AUTO", "RT+", "RT-" faulty cases.....	19
6.2. M $\Omega$ : Insulation resistance Measurement with 50V, 100V, 250V, 500V, 1000V Test Voltage .....	21
6.2.1. Measurement Procedure .....	21
6.2.2. Results of "MAN" mode .....	23
6.2.3. Results of "TMR" mode.....	24
6.2.4. "MAN" and "TIMER" mode faulty cases.....	25
6.3. RCD: Test on "A" and "AC" RCDs Type .....	26
6.3.1. Tripping times for the general and selective RCDs.....	28
6.3.2. Measurement procedure.....	29
6.3.2.1. Results of "x1/2" mode .....	30
6.3.2.2. Results of "x1, x2, x5" mode.....	31
6.3.2.3. Results of "AUTO" mode.....	32
6.3.2.4. Results of "RAMP  mode .....	33
6.3.2.5. Results of " R <sub>A</sub>  mode .....	34
6.3.3. RCD Faulty cases .....	35
6.3.3.1. Connection troubles.....	35
6.3.3.2. RCD tripping "faulty cases" .....	37
6.4. LOOP  : Measurement of Line Impedance, Fault loop Impedance, Prospective Short Circuit Current Calculation and Phase Sequence Indicator .....	40
6.4.1. High resolution Impedance measurement (0.1m $\Omega$ ) .....	40
6.4.2. Measurement procedure and results of "P-N" mode .....	41
6.4.3. Measurement procedure and results of "P-P" mode.....	43
6.4.4. Measurement procedure and results of "P-PE" mode .....	45
6.4.5. Measurement procedure and results of " R <sub>A</sub>  mode .....	47
6.4.6. Measurement procedure and results of "  mode .....	49
6.4.7. LOOP  Faulty Cases .....	50

6.5. EARTH: Soil Resistance and Resistivity Measurements .....	55
6.5.1. Measurement procedure and results of "2-W"and "3-W" mode .....	56
6.5.2. Measurement procedure and results of "ρ" mode .....	58
6.5.3. "2-W", "3-W" and "ρ" faulty cases .....	59
6.6. LOW10A: Continuity Test with 10A Test Current (GSC57 ONLY) .....	62
6.6.1. Measurement Procedure and Result of "RMEAS" mode .....	63
6.6.2. Measurement Procedure and Result of "VDROP" mode .....	64
6.6.3. "RMEAS" and "VDROP" faulty cases .....	65
<b>7. AUX: MEASUREMENT WITH EXTERNAL PROBES .....</b>	<b>67</b>
7.1. ENVIRONMENTAL PARAMETER AND LEAKAGE CURRENT: REAL TIME MEASUREMENT .....	68
7.2. ENVIRONMENTAL PARAMETER AND LEAKAGE CURRENT: RECORDING .....	70
7.2.1. AUX Basic setting: RECORDER CONFIG .....	70
7.2.2. RECORDING: setting of Typical Configurations .....	72
<b>8. ANALYSER .....</b>	<b>73</b>
8.1. Basic Setting: ANALYSER CONFIG .....	74
8.1.1. How to set the type of electrical system under test .....	74
8.1.2. How to set the fundamental frequency .....	74
8.1.3. How to set the current range .....	74
8.1.4. How to set the Clamp Type .....	75
8.1.5. How to set the value of the transformer voltage ratio (TV RATIO) .....	75
8.1.6. How to enable/disable the password .....	75
8.2. Basic Setting: RECORDER CONFIG .....	76
8.3. ANALYSER FUNCTIONS .....	83
8.4. "VOLTAGE" Function .....	84
8.4.1. Symbols .....	84
8.4.2. "METER" mode .....	85
8.4.3. "HARM" mode .....	86
8.4.4. "WAVE" mode .....	87
8.5. "CURRENT" Function .....	88
8.5.1. Symbols .....	88
8.5.2. "METER" mode .....	89
8.5.3. "HARM" mode .....	90
8.5.4. "WAVE" mode .....	91
8.6. "POWER" Function .....	92
8.6.1. Symbols .....	92
8.6.2. "METER" mode .....	93
8.6.2.1. PEAK ENERGY DEMAND .....	94
8.6.3. "WAVE" mode .....	95
8.7. "ENERGY" Function .....	96
8.7.1. Symbols .....	96
8.7.2. "METER" mode .....	97
8.8. Measuring Procedures .....	98
8.8.1. Using the Instrument in a Single Phase System .....	98
8.8.2. Using the Instrument in a Three Phase 4 Wire System .....	99
8.8.3. Using the Instrument in a Three Phase 3 Wire System .....	101
<b>9. SAVING RESULTS .....</b>	<b>103</b>
9.1. Saving Safety Test Results .....	103
9.2. Saving Displayed Values of ANALYSER Function .....	103
<b>10.RECORDINGS .....</b>	<b>104</b>
10.1. Start a Recording .....	104
10.2. Setting Typical Configurations .....	105
10.2.1. Default Configuration .....	105
10.2.2. Typical Configurations .....	106
10.3. During A Recording .....	110
10.3.1. MENU key .....	110
10.3.2. Rotary Switch during a recording .....	111
10.4. Stopping A Recording Or An Energy Measurement .....	112
<b>11.INSTRUMENT'S MEMORY .....</b>	<b>113</b>
11.1. SAFETY TEST MEMORY .....	113

11.2. ANALYSER MEMORY .....	114
<b>12. CONNECTING THE INSTRUMENT TO A PC .....</b>	<b>115</b>
<b>13. CONNECTION THROUGH BLUETOOTH PROTOCOL.....</b>	<b>115</b>
<b>14. MAINTENANCE.....</b>	<b>116</b>
14.1. General Instruction.....	116
14.2. Battery Replacement .....	116
14.3. Instrument Cleaning.....	116
14.4. END OF LIFE.....	116
<b>15. TECHNICAL SPECIFICATIONS .....</b>	<b>117</b>
15.1. Technical Features .....	117
15.1.1. Safety Test functions .....	117
15.1.2. ANALYSER and AUX functions.....	119
15.2. Standards .....	120
15.2.1. General.....	120
15.2.2. EMC.....	120
15.2.3. Safety Test.....	120
15.2.4. ANALYSER.....	120
15.3. General Specifications.....	121
15.3.1. Mechanical Data .....	121
15.3.2. Power supply .....	121
15.3.3. Display.....	121
15.3.4. Memory.....	121
15.4. ENVIRONMENT .....	121
15.5. ACCESSORIES .....	122
<b>16. SERVICE .....</b>	<b>124</b>
16.1. WARRANTY CONDITIONS.....	124
16.2. SERVICE .....	124
<b>17. PRACTICAL REPORTS FOR ELECTRICAL TESTS .....</b>	<b>125</b>
17.1. Continuity Test on Protective Conductors.....	125
17.2. Insulation Resistance Measurement of The Electrical Installations (250Vdc, 500Vdc, 1000Vdc).....	127
17.3. Check of the Circuit Separation .....	130
17.4. Earth Resistance Measurement in TT Systems.....	133
17.5. Working Test of Rcds (Rcd, Rcd/Dc, Rcd S, Rcd/Dc S) .....	134
17.6. Test of Rcd Tripping Time (Rcd, Rcd/Dc) .....	135
17.7. Measurement of Short-Circuit Fault Impedance ( $Z_{pn}$ , $Z_{pp}$ ).....	136
17.8. Fault Loop Impedance Measurement (Phase – Earth) .....	136
17.9. Earth Resistivity Measurement .....	137
17.10. Voltage Anomalies (Voltage Sag and Surge) .....	139
17.11. Voltage and current Harmonics .....	139
17.11.1. Theory.....	139
17.11.2. Limit values for harmonics .....	141
17.11.3. Presence of harmonics: causes.....	141
17.11.4. Presence of harmonics: consequences .....	142
17.12. Power and Power Factor Definition .....	142
17.12.1. Conventions on powers and power factors.....	144
17.12.2. 3 Phase 3 Wire System.....	145
17.13. Measuring Method: outlines .....	146
17.13.1. Integration periods .....	146
17.13.2. Power factor calculations .....	146
<b>18. APPENDIX 1 – MESSAGES DISPLAYED .....</b>	<b>147</b>
<b>19. APPENDIX 2 – RECORDABLE PARAMETERS: SYMBOLS.....</b>	<b>148</b>

## 1. SAFETY PRECAUTIONS AND PROCEDURES

### 1.1. GENERAL

This apparatus conforms with safety standards EN61557 and EN61010-1 relating to electronic measuring instruments.



#### WARNING

For your own safety as well as that of the apparatus you are recommended to follow the procedures described in this instruction manual and carefully read all the notes preceded by the symbol

Strictly keep to the following instructions before and during measurements:

- ☞ Do not take measurements in wet environments or dusty places.
- ☞ Do not effect measurements in environments with explosive gas, fuels.
- ☞ Keep you insulated from the object under test waiting for measuring.
- ☞ Avoid any contact with exposed metal parts, ends of test leads not in use, circuits, etc.
- ☞ Do not effect any measurement in case of unusual conditions of the instrument such as deformation, breakage, leakage of substances, absence of display reading etc.
- ☞ Do not use the External power supply adapter (code A0050, optional for GSC57) if you notice deformation, or breakage in the case, in the wire or in the plugs.
- ☞ Pay careful attention when measuring voltages exceeding 25V in particular places (building yards, swimming pools, etc.) and 50V in ordinary places because of the risk of electric shock.
- ☞ Use only cables and accessories approved by HT ITALIA.

The following symbols are used in this manual:



Caution: refer to the instructions reported on this manual; improper use may damage the apparatus or its components.



AC Voltage or Current.



Unidirectional pulsating Voltage or Current.



Rotary switch of the instrument.

### 1.2. PRELIMINARY INSTRUCTION

- ☞ This instrument has been designed for use in environments with a pollution level 2 and up to (and no more than) 2000 meters altitude.
- ☞ It can be used for Safety Test on Installation with Overvoltage Category III 300V~ (phase to earth) and for **voltage and current** measurements on installations with overvoltage category III 600 V~ phase to phase / 300 V~ phase to earth or CATII 350 V phase to earth.

- ☞ Please keep to the usual safety standards aimed at:
  - ◆ Protecting against dangerous currents;
  - ◆ Protecting the instrument against incorrect operations.
- ☞ Only the accessories supplied with the instrument guarantee compliance with the safety standards. Accordingly, they must be in good conditions and, if necessary, they must be replaced with identical models.
- ☞ Do not take measurements on circuits exceeding the specified current and voltage limits.
- ☞ Before connecting cables, crocodiles and clamps to the circuit under test, make sure that the right function has been selected.
- ☞ Do not effect any measurement under environmental conditions beyond the limits specified in paragraph 15.4.
- ☞ Check that batteries are not weak and placed correctly.
- ☞ Before connecting test leads to the circuit under test, check that rotary switch position is correct.

### 1.3. DURING USE

Please read carefully the following recommendations and instructions:



#### WARNING

No compliance with the Warnings and/or Instructions may damage the apparatus and/or its components or injure the operator.

- ☞ Before selecting any function disconnect the test leads from the circuit under test.
- ☞ When the instrument is connected to the circuit under test do not touch any unused terminal.
- ☞ Avoid to effect resistance measurements in the presence of external voltages; even though the instrument is protected a too high voltage may cause malfunctions.
- ☞ When measuring current, other currents located near the leads may affect the measuring accuracy.
- ☞ When measuring current, always position the wire in the very middle of the jaws in order to obtain the highest accuracy.
- ☞ A measured value remains constant if the "HOLD" function is active. Should you notice that the measured value remains unchanged, disable the "HOLD" function.



#### WARNING

The symbol "■" shows the battery charge: When it is completely black the battery are full charge, while the "□" symbol indicate weak batteries. When the batteries are too low to execute the test the instrument will show a warning message. In the case interrupt testing and replace batteries following the procedure described under paragraph 14.2. **The instrument is capable of keeping the data stored even though batteries are not installed. The Instrument Date and Time settings aren't lost if you change the batteries within 24hours.**

### 1.4. AFTER USE

- After use, turn off the instrument by pressing ON/OFF for a few seconds.
- Remove batteries when the apparatus remains unused for long periods. Please follow the storage instructions described at paragraph 15.4.

## 2. GENERAL DESCRIPTION

### 2.1. INTRODUCTION

Dear Customer, we thank you for your patronage. The instrument you have just purchased will grant you accurate and reliable measurements provided that it is used according to the present manual's instructions.

The instrument was designed to grant the user the utmost safety conditions thanks to a new concept assuring double insulation and over voltage category III.



**This instruction manual is referred to three models: GSC57, GSC53N and ZG47.**

Differences among models are:

- **LOW $\Omega$ 10A** function performed by **GSC57 model only**.
- Use of **HTFLEX33** flexible clamps 1000A/3000A without any external control logic, available with **models GCS53N and ZG47**.

### 2.2. FUNCTIONS

The instrument is able to perform the following test:

- ☞ **LOW $\Omega$ :** Continuity Test of Protection and Equalising conductors with test current higher than 200mA and open circuit voltage ranging from 4V to 24V.
- ☞ **M $\Omega$ :** Measurement of insulation resistance with DC test voltage 50V, 100V, 250V, 500V or 1000V.
- ☞ **RCD:** Measurement on common and/or selective RCDs AC type () and A type () of the following parameters:
  - ✓ Tripping time.
  - ✓ Tripping current.
  - ✓ Contact voltage ( $U_t$ ).
  - ✓ Global earth resistance ( $R_a$ ).Under this mode the instrument can measure the overall earth resistance without causing RCD tripping.
- ☞ **LOOP** : Measurement of line and fault loop impedance with calculation of prospective short circuit current, Measurement of fault loop impedance between phase and earth and Global Earth resistance measurement without RCD tripping and calculation of prospective short circuit current, Indication of phase rotation sequence
- ☞ **EARTH** Measurement of Earth Resistance and Resistivity using Earth rods.
- ☞ **LOW $\Omega$ 10A:** Continuity Test of Protection and Equalising conductors with test current higher than 10A (**GSC57** only).
- ☞ **AUX:** Measurement and Recording of leakage current and environmental values (temperature, humidity, Air Speed, illuminance and Sound level).
- ☞ **ANALYSER:** The Instrument allows the following operations:
  - ✓ **display in real time** the electrical parameters of a single phase and three-phase systems (with and without neutral wire) and the harmonic analysis of voltages and currents.
  - ✓ **conduct a direct Energy measurement** (without memorizing).
  - ✓ **memorize** (pressing **SAVE** key) the sampled values of the Parameters present at instrument input generating a "Smp" record inside instrument memory. **It will be possible to analyse the memorized data ONLY by transferring it to a PC.**



- ✓ **record simultaneously** (pressing the **START** key after a proper setting): RMS values of voltages, currents, corresponding harmonics, active, reactive and apparent powers, power factors and  $\cos\phi$ , active, reactive and apparent energies, voltage anomalies (voltage sag and surge) with 10ms resolution. **It will be possible to analyse the recorded data ONLY by transferring them to a PC.**
- ✓ **record simultaneously** (pressing the **START** key) values of Voltage and Current values coming from test leads and Clamps, using “**Typical Configurations**” with pre-programmed parameters inside meter (see paragraph ). **It will be possible to analyse the recorded data ONLY by transferring them to a PC.**

### WARNING



Please note the difference between **memorize** and **record**. These terms will be used repeatedly in this manual. Please focus on their definitions and distinctions.

### 3. PREPARATION FOR USE

#### 3.1. INITIAL CONTROL

This instrument has been checked mechanically and electrically prior to shipment. Any care has been taken to ensure that the instrument reaches you under safe conditions.

You are recommended, however, to carry out a rapid check to detect any possible damage which might have been caused during transport. Should this be the case, immediately contact HT Italia.

Check also that the packaging contains all the parts listed under paragraph 15.5. In case of discrepancies contact the dealer.

In case you have to send the instrument back please follow the instructions reported in paragraph 16.



#### 3.2. POWER SUPPLY

The instrument can be powered by:

- ✓ 6 batteries 1.5V AA - LR6 series located in the compartment on the back of the instrument (not included in the package). For battery life see paragraph 15.3.2.
- ✓ an external power supply adapter (code A0050, optional for GSC57) **to be used only for ANALYSER and AUX function**. We recommend You to use only A0050 HT Power Supply adapter.

**For your own safety it's not allowed to use the external power supply adapter during Safety Test (LOW $\Omega$ , M $\Omega$ , RCD, LOOP, EARTH rotary Switch positions). If you press the START button the Instrument will show the message " $\Delta$  REMOVE POWER".**

For batteries replacement please refer to paragraph 14.2.

The symbol  shows the battery charge: If it is completely "black" the battery are full charge, while the  symbol indicate weak batteries. When the batteries are too low to execute the test the instrument will show a warning message.

In the case interrupt testing and replace batteries following the procedure described under paragraph 14.2. **The instrument is capable of keeping the data stored even though batteries are not installed. The Instrument Date and Time settings do not get lost if you change the batteries within 24hours.**

**WARNING**

For recordings (ANALYSIS and AUX function) use **ALWAYS** the external power supply adapter (code A0050, optional for GSC57) even the instrument allows the operator to perform a recording using internal batteries. If during a recording the external power supply adapter is de-energised, the instrument will continue the recording using the internal battery power until the batteries are exhausted (the data stored up to the point the instrument shuts down won't get lost). For this we recommend you **ALWAYS insert a new set of batteries before a long recording.**

The instrument uses sophisticated algorithms to prolong the battery life. Particularly:

- ✓ The instrument switches OFF the backlight Automatically after 5 seconds.
- ✓ If the instrument is displaying in real time (and the external power supply adapter is not connected), after about 5 minutes from the last key pressure or switch rotation the instrument turns off automatically ("AUTOPOWER OFF" procedure).
- ✓ If the instrument is recording or is measuring energy (and the external power supply is not connected), after about 5 minutes from the last key pressure or switch rotation the instrument starts a special procedure to save the batteries ("ECONOMY MODE"): the instrument keeps recording but the display is turned off.

### 3.3. CALIBRATION

The instrument fulfils the technical specifications listed in this manual. The performance of the specifications are guaranteed for one year.

### 3.4. STORAGE

In order to grant the accuracy of the measurements, after a period of storage in extreme environmental conditions, wait for the time necessary so that the apparatus is back to normal measuring conditions (see environmental specifications listed in paragraph 15.4).

## 4. INSTRUMENT DESCRIPTION

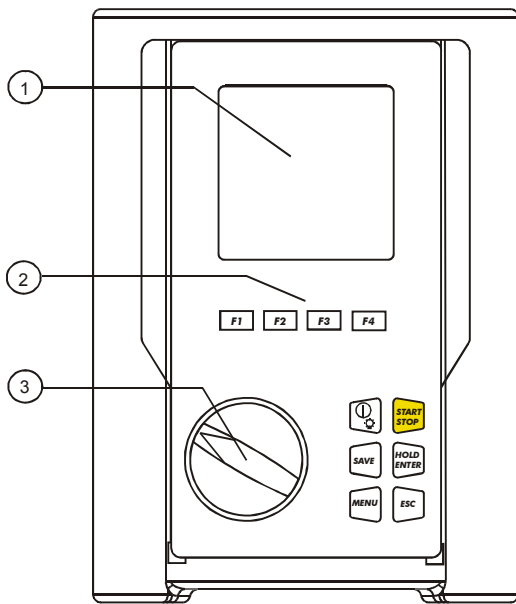

LEGEND:

1. Display
2. Function Keys
3. Rotary switch

Front panel of the Instrument

**F1 F2 F3 F4** ➔ Multifunction Keys.

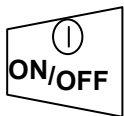

➔ **ON/OFF** and backlight key. Press it for few seconds to switch OFF the instrument, press it briefly to activate the backlight function.



➔ This key start (and stop). the measurement.



➔ This key allows to save the result displayed.



➔ This key has a double function: it is the confirmation key inside the configuration menu and it allows to freeze the displayed results using the ANALYSER function.

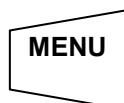

➔ This key open the General Configuration Menu.



➔ This key quit the .modification in the configuration menu or the selected working mode.

#### 4.1. DISPLAY DESCRIPTION

The display is a graphic module with a resolution of 128 x 128 pixels

The first line of the display shows date and time. If not correct, you can set the exact ones according to the procedure described at paragraph 5.2.

On the top right corner of the display you can always see the battery indicator and, if the external power supply adapter (code A0050) is connected, the corresponding symbol.

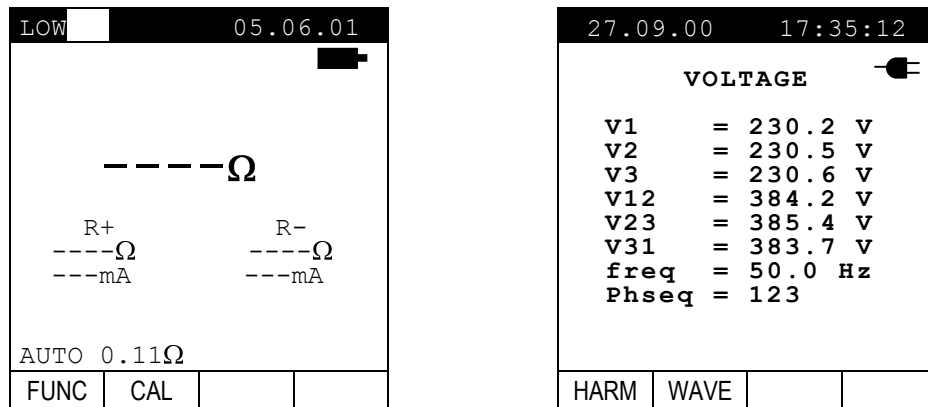

These symbols will be omitted in the following illustrations.

#### 4.2. INITIAL SCREEN

When turning on the instrument by pressing ON/OFF, this screen will appear for a few seconds:



Here you can see:

- serial number of the instrument (SN.:
- firmware software release (V.X.XX:)
- transmission speed through serial RS232 (Baud Rate)
- calibration date (CALIBRATION:)

#### 4.3. BACKLIGHT FUNCTION

When instrument is turned on, pressing briefly the **ON** button, the backlight will be enabled. The light will be automatically turned off after 5 seconds.

If the batteries are too low the instrument will disable automatically the backlight function.

## 5. INITIAL SETTINGS

By pressing the **MENU** key the following screen will be displayed:

MENU GENERAL			
<b>SAFETY TEST MEMORY</b>			
ANALYSER MEMORY			
RESET			
ANALYSER CONFIG		RECORDER CONFIG	
CONTRAST			
DATE & TIME			
LANGUAGE			
↓	↑		

It's not possible to enter the **MENU** during a recording or a Real Time Energy measurement. Pressing this button during a recording the display will show main recording parameter (see paragraph 10.3)

### 5.1. HOW TO ADJUST THE CONTRAST

By pressing the keys **F1** and **F2**, position the cursor on the **CONTRAST** item and confirm it by pressing the **ENTER** key.

By pressing the keys **F3** and **F4**, adjust the contrast (higher values correspond to a higher contrast while lower values correspond to a lower contrast) and press the **ENTER** key to SAVE the change or press **ESC** to quit the modification.

This setting will remain unchanged after turning off the instrument.

### 5.2. HOW TO SET DATE AND TIME

By pressing the keys **F1** and **F2**, position the cursor on the **DATE&TIME** item and confirm it by pressing the **ENTER** key.

The time is expressed as **hh:mm** (2 digit for hours, 2 digit for minutes) military time.

Press the **ENTER** key to SAVE the change or press **ESC** to quit the modification.

This setting will remain unchanged also after turning off the instrument.

### 5.3. HOW TO SET THE LANGUAGE

By pressing the keys **F1** and **F2**, position the cursor on the **LANGUAGE** (EN) or **LINGUA** (IT) item and confirm it by pressing the **ENTER** key.

By pressing the keys **F1** and **F2**, position the cursor on the desired language and press the **ENTER** key to SAVE the change or press **ESC** to quit the modification.

This setting will remain unchanged after turning off the instrument.

## 5.4. RESET

This option re-establishes the initial settings of the instrument in **ANALYSER** function.

The RESET command re-establishes the limit value on Insulation measurement (see paragraph 6.2) at 0.5M $\Omega$  and test voltage at 500V.

The “not modified” parameter it is not modified by RESET command

The initial settings of the instrument consist of:

### ✓ ANALYSER CONFIG:

System:	3PH4W
Frequency:	not modified
Current range:	not modified
Clamp type:	not modified
Transforming ratio of voltmetric transformers:	1
Password:	OFF

### ✓ RECORDER CONFIG:

Start:	MANU (the recording is started at 00 sec mark on clock after pressing the <b>START/STOP</b> key)
Stop:	MANU
Integration period:	15min
Recording of harmonics:	ON
Recording of Voltage anomalies (Sag and Surge):	ON
Voltage Reference for Sag and Surge detection:	230V
Upper Limit for Sag and Surge detection:	6%
Lower Limit for Sag and Surge detection:	10%
Selected voltages:	V1, V2, V3
Selected voltage harmonics:	THD, 01, 03, 05, 07
Selected currents:	I1, I2, I3, IN
Selected current harmonics:	THD, 01, 03, 05, 07
CO-GENERATION:	OFF
Powers, Pf and $\cos\varphi$ selected:	Pt, P1, P2, P3 Qti, Q1i, Q2i, Q3i Qtc, Q1c, Q2c, Q3c St, S1, S2, S3 Pft, Pf1, Pf2, Pf3 dpft, dpf1, dpf2, dpf3
Energies:	Eat, Ea1, Ea2, Ea3 Erit, Eri1, Eri2, Eri3 Erct, Erc1, Erc2, Erc3

The RESET command will not erase the instrument's memory.

## 6. SAFETY TEST FUNCTIONS

### 6.1. LOW $\Omega$ : CONTINUITY TEST WITH 200mA TEST CURRENT



#### WARNING

Before carrying out the continuity test make sure that there is no voltage at the ends of the conductor under test.

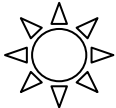

Turn the **switch** on **LOW $\Omega$**  position.

#### F1

This key permits to select one of the following measuring modes:

- ☞ Mode "**AUTO**" (the instrument carries out two measurements with reversed polarity and displays their average value). This mode is recommended for the continuity test.
- ☞ Mode "**RT+**" (measurement with positive polarity and possibility of setting the duration time of the test). In this case the operator can set a measuring time long enough to permit him to move the protective conductors while the instrument is carrying out the test so detecting any bad connection.
- ☞ Mode "**RT-**" (measurement with negative polarity and possibility of setting the duration time of the test). In this case the operator can set a measuring time long enough to permit him to move the protective conductors while the instrument is carrying out the test so detecting any bad connection.

#### F2

This key permits to execute the "**CAL**" mode (compensation of the resistance of the cables used for the measurement).



#### WARNING

If the resistance is lower than **5 $\Omega$**  (including the resistance of the calibration) the continuity test is executed by the instrument with a test current higher than 200mA. If the resistance is higher than 5 $\Omega$  the continuity test is executed by the instrument with a current lower than 200mA.

#### N.B.

We recommend you to check the Calibration of the test leads before executing a measurement according to next paragraph.



### 6.1.1. Calibrating the test leads ("CAL" Mode)

1. Connect the black and blue test leads to **B1** and **B4** input terminals respectively.

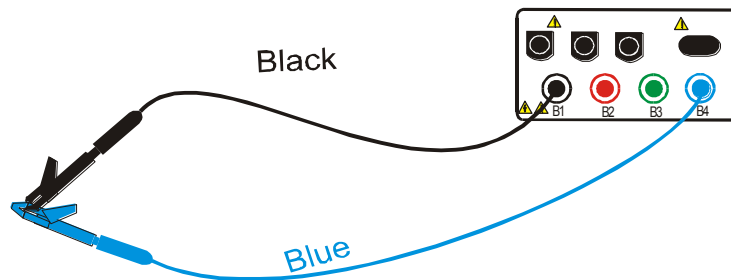

#### Connection of instrument terminals during calibration procedure.

2. If the test leads supplied with the instrument are not long enough for the measurement you can extend the blue cable.
3. Short-circuit the measuring cable ends making sure that the conductive parts of the crocodiles make a good contact to each other (see previous picture).
4. Press the **F2** key. The instrument carries out the calibration.

**F2**



#### WARNING

Never disconnect the test leads when the message **"MEASURING"** is displayed.

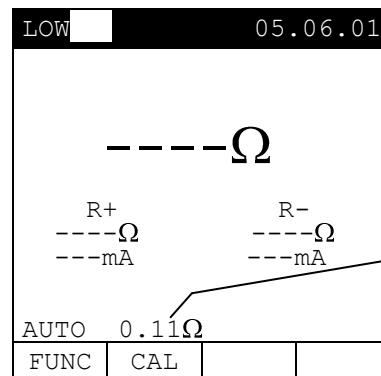

A numerical value in this field means that the instrument has been calibrated; this value **remains on the display for any further measurement** even though the unit is switched off and on again.

5. At the end of the test the result is stored and used as **OFFSET (that is to say that it is subtracted from any continuity test carried out)** for all the subsequent measurements.

**Note:**

The instrument effects the calibration only if the resistance of the test leads is lower than  $5\Omega$ .

## TEST LEADS

Before each measurement always make sure that the calibration is referred to the cables in use. During a continuity test, if the resistance value free of calibration (that is the resistance value less the calibration offset value) is **negative**, the symbols  $\Delta$  is displayed. Probably the calibration resistance value stored in the instrument memory is not referred to the cable in use, therefore a new calibration must be effected.

### 6.1.1.1. Procedure to reset test leads' calibration parameters

☞ To cancel calibration parameters it is necessary to effect a **calibration procedure with a resistance of test leads higher than 5Ω** (for example with open test leads). When a cancellation is effected **the screen nearby** is displayed first, followed by the screen below:

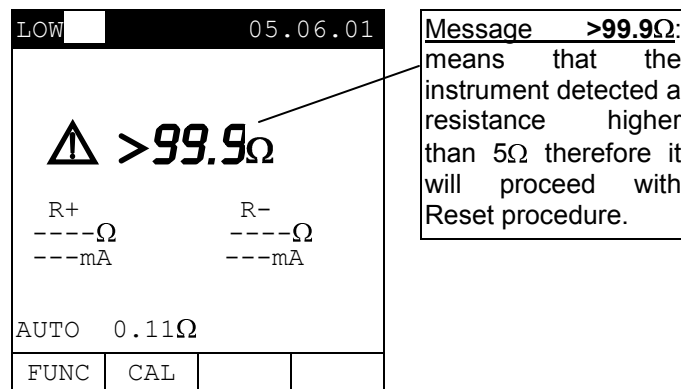

### 6.1.2. Measurement Procedure

**F1**

1. Select the desired mode by means of the **F1** key.
2. Connect the black and blue test leads to **B1** and **B4** input terminals respectively

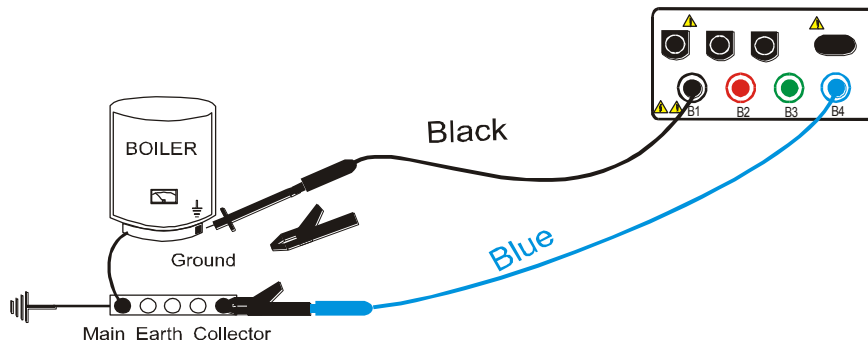

#### Connection of the test leads during LOWΩ test.

3. If the cables supplied with the instrument are not long enough for the measurement you can extend the blue cable.
4. Short-circuit the test leads making sure that the conductive parts of the crocodiles make a good contact to each other. Press the **START** key. **If the display doesn't show 0.00Ω repeat the test leads calibration** (see paragraph 6.1.1).
5. Connect the instrument terminals to the ends of the conductor under test (see previous picture).
6. **If the mode "RT+" or "RT-" was selected use the F3, F4 keys to set the duration of the test.**
7. Press the **START** key. The instrument will execute the measurement. In RT+/RT- (Timer mode) you can press **START** key again if you want to stop the test before the duration set is expired.

**F3**
**F4**
**START  
STOP**

#### WARNING

Never disconnect the test leads when the message **"MEASURING"** is displayed.

### 6.1.3. Results of "AUTO" mode

☞ At the end of the test, if the **average resistance value  $R_{avg}$  is lower than  $5\Omega$**  the instrument emits a **double sound signal** indicating the **positive outcome of the test** and displays one screen similar to the screen alongside.

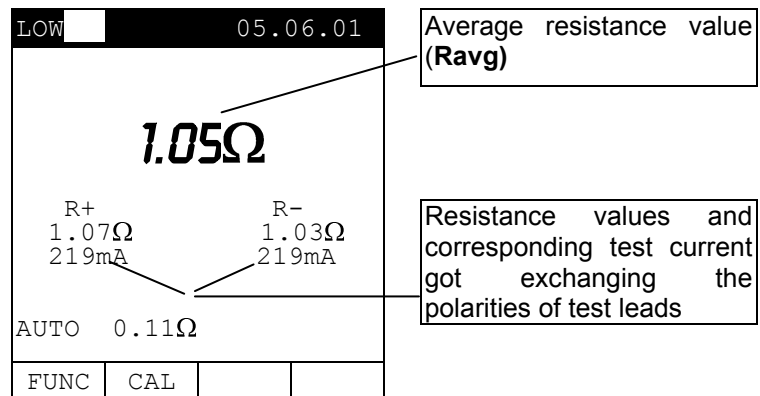

The displayed result can be stored pressing the **SAVE** key **twice** (according to paragraph 9.1).

### 6.1.4. Results of "RT+" and "RT-" modes

☞ if a **resistance value  $RT+$  or  $RT+$  lower than  $5\Omega$**  is detected, the instrument emits a **double sound signal** indicating the **positive outcome** of the test displays one screen similar to the screen alongside.

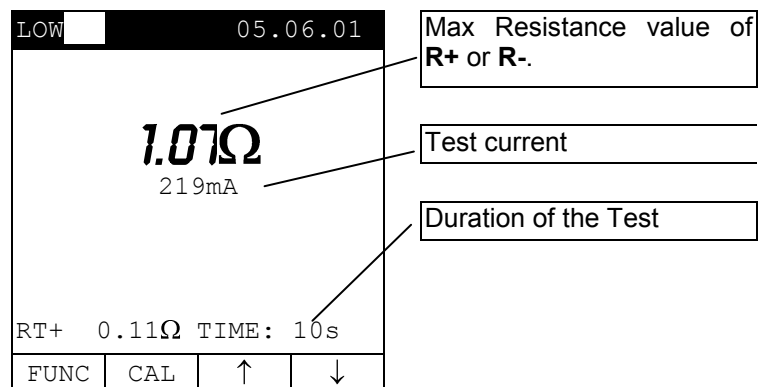

**Note:** We recommend to use crocodiles and to check if the crocodiles make a good contact with the conductor under test. Indeed in this test the instrument gives as final result the maximum measured value of  $R+$  or  $R-$  and using test leads instead of crocodiles could give you faulty result due to faulty contact between the test leads and conductor under test



The displayed result can be stored pressing the **SAVE** key **twice** (according to paragraph 9.1).

### 6.1.5. "AUTO", RT+", "RT-" faulty cases

☞ If the instrument detect the External Power supply adapter connected to instrument will show the message displayed to side.

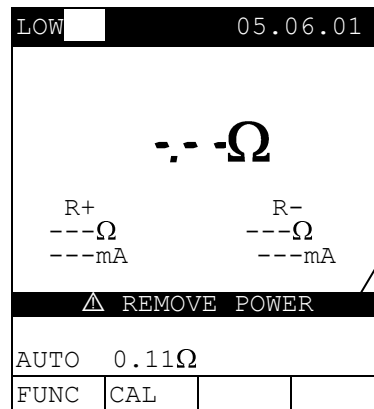

**Disconnect the External Power Supply Adapter**

☞ If the terminal voltage is higher than 15V, the instrument does not carry out the test and displays the screen alongside for 5 seconds.

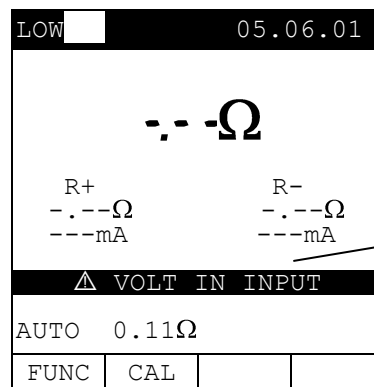

**ATTENTION: the test was not effected** because of voltage at the terminal ends.

☞ In case that:  $R_{CALIBRATION} > R_{MEASURED}$  the instrument displays the screen alongside.

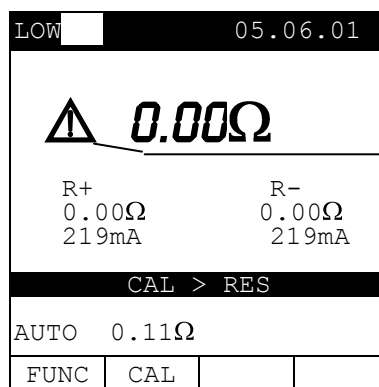

**ATTENTION:**  
 $R_{CALIBRATION} > R_{MEASURED}$

**THE PREVIOUS RESULTS CANNOT BE SAVED.**

If the value of **Resistance is higher than  $5\Omega$**  (but lower than  $99.9\Omega$ ) the instrument emits a long sound signal and displays one screen similar to the screen alongside

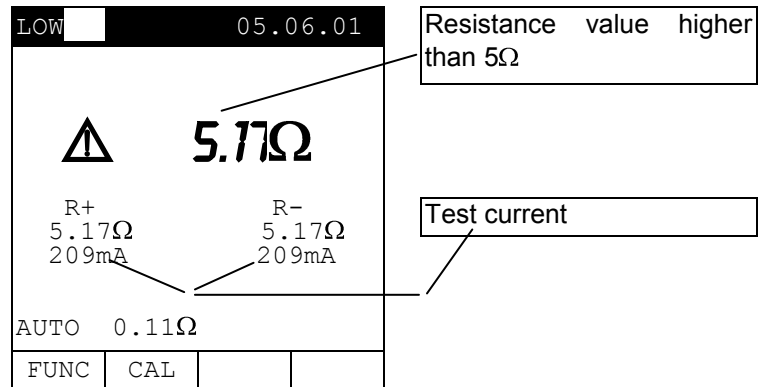

The displayed result can be stored pressing the **SAVE** key **twice** (according to paragraph 9.1).

If the value of **Resistance is higher than  $99.9\Omega$**  the instrument emits a long sound signal and displays the screen alongside.

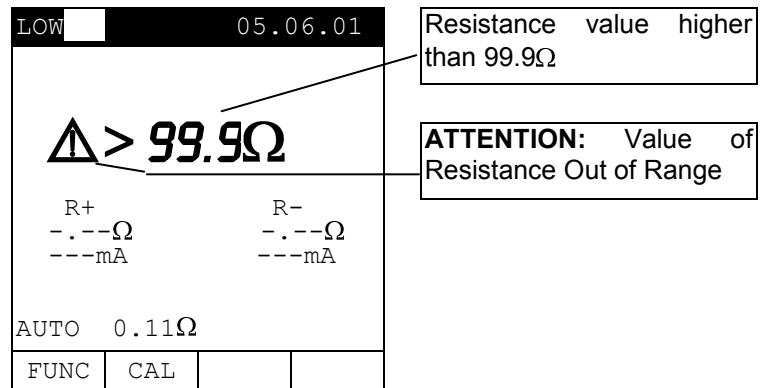

The displayed result can be stored pressing the **SAVE** key **twice** (according to paragraph 9.1).

## 6.2. MΩ: INSULATION RESISTANCE MEASUREMENT WITH 50V, 100V, 250V, 500V, 1000V TEST VOLTAGE



### WARNING

Before effecting the insulation test make sure that the circuit under test is not energised and all the loads are disconnected.

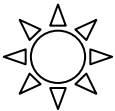

Turn the **switch** on **MΩ** position.

### F1

The key **F1** permits to select one of the following measuring modes:

- ☞ Mode "**MAN**" (Manual mode). Recommended test.
- ☞ Mode "**TMR**" (Timer mode: test duration depends on the selected interval from 10 to 999 seconds). This test can be executed when the test required a defined duration.

### 6.2.1. Measurement Procedure

#### F1

1. Select the desired mode by means of the **F1** key.
2. Connect the test leads to the instrument input terminals **B1** and **B4** respectively,

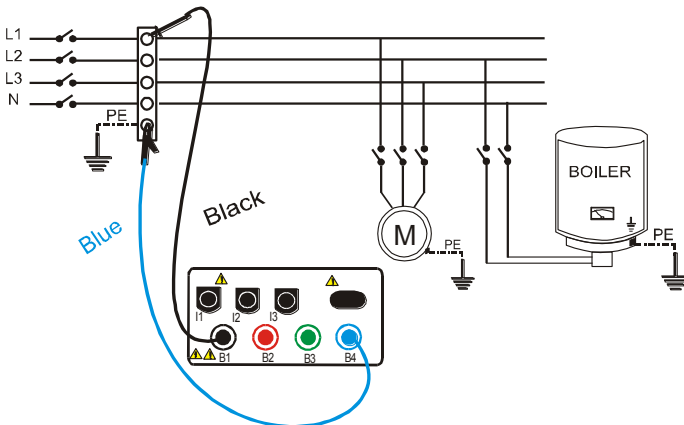

**Example: insulation measurement between phase and earth in an electrical installation using untied cables.**

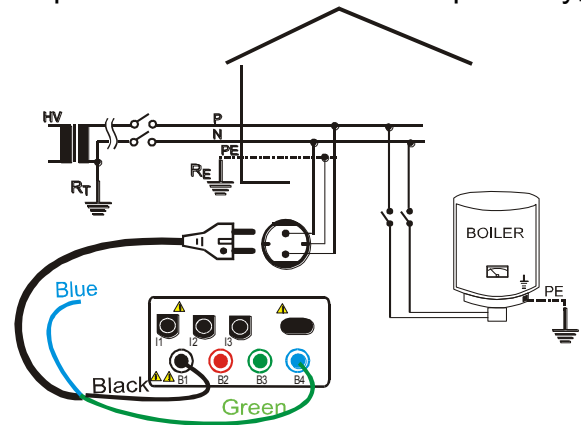

**Example: insulation measurement between phase and earth in an electrical installation using the shuko cable.**

3. If the cables supplied with the instrument are not long enough for the measurement you can extend the blue cable.
4. Connect the instrument terminals to the object which is to be submitted to the insulation test **after de-energizing the circuit under test and all the relative loads** (see previous picture).

#### F2

5. By means of **F2** select the test voltage suitable for the type of test to be carried out (see Table1). The values to be selected are:
  - 50V (test on telecommunication system)
  - 100V
  - 250V
  - 500V
  - 1000V

Standard	Brief description	Test voltage	Maximum limit value
EN60439	Electrical panel boards 230/400V	500VDC	> 230kΩ
EN60204	Electrical equipment of machines	500VDC	> 1MΩ

Table1: Table reporting the test voltage and the corresponding limit values for few Guidelines.

Rated voltage selected for the test	R <sub>MAX</sub> = Maximum resistance value
50VDC	99.9MΩ
100VDC	199.9MΩ
250VDC	499MΩ
500VDC	999MΩ
1000VDC	1999MΩ

Table2: Table of maximum resistance values which can be measured under MΩ mode depending on the rated voltage selected.

- F3**  
**F4**
6. Using **F3**, **F4** is possible to set minimum limit for Insulation measurement selected one of following values: **0.05MΩ**, **0.1MΩ**, **0.23MΩ**, **0.25MΩ**, **0.50MΩ**, **1.00MΩ**, **100MΩ** according to Table1.



### WARNING

The value of set limit in "**MAN**" mode is used in "**TIMER**" mode also, although the "**LIM**" message doesn't appear at display.

- F3**  
**F4**
7. If the "**TMR**" mode was selected use the **F3**, **F4** keys to set the duration time of the test:



### WARNING

Never disconnect the test leads from the circuit under test when the message "**MEASURING**" is displayed as the circuit under test may remain charged at a dangerous voltage. The instrument has an internal "safety resistor" which is connect to output terminal before end of test in order to discharge the parasite capacities of the installation.



8. Press the **START** key.

The instrument will start the test.

- ✓ MAN Mode: The test will take 4 seconds (maximum). If you keep the **START** key pressed longer than 4 seconds the test go on until the key is released.
- ✓ TMR mode: The test will take the time set. If you want to stop the test when it's running, press the **START** key again.



### 6.2.2. Results of "MAN" mode

☞ At the end of the test if the Insulation resistance is **lower than  $R_{MAX}$**  (see Table2), upper to set limit value **and the instrument generated the Nominal test Voltage**, the instrument emits a **double sound signal indicating the positive outcome of the test** and displays one screen similar to the screen alongside.

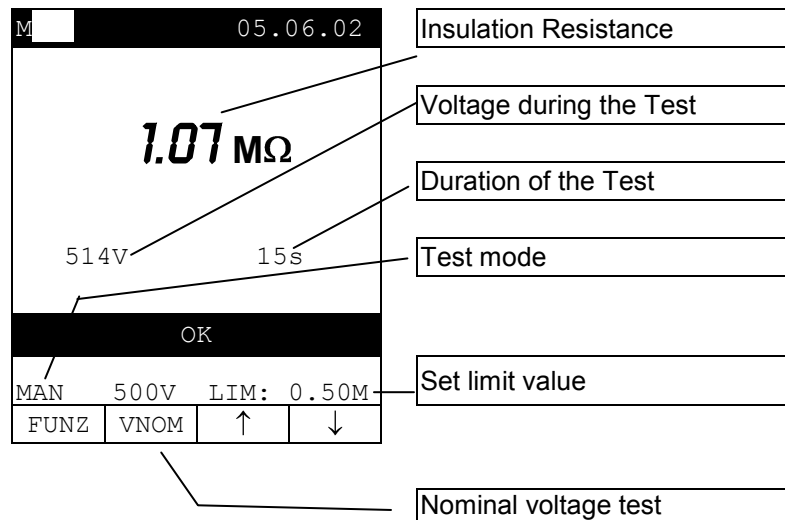

The displayed result can be stored pressing the **SAVE** key **twice** (according to paragraph 9.1).

☞ If the Insulation resistance is **higher than  $R_{MAX}$**  (see Table2), the instrument emits a **double sound signal** at the end of the test **indicating the positive outcome of the test** and displays one screen similar to the screen alongside.

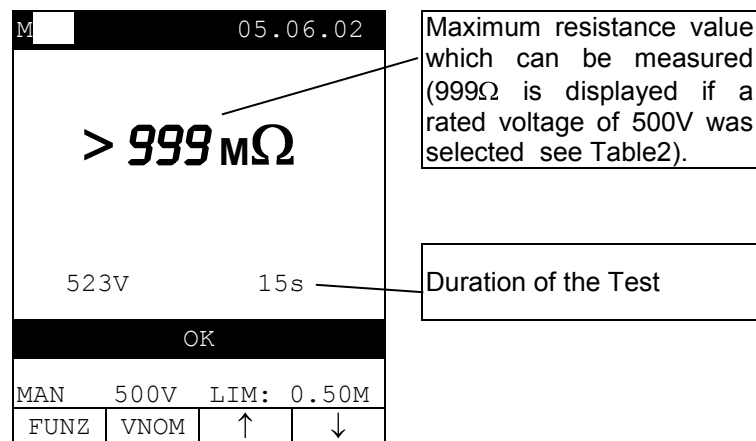

The displayed result can be stored pressing the **SAVE** key **twice** (according to paragraph 9.1).

### 6.2.3. Results of "TMR" mode

☞ At the end of the test if the Insulation resistance is **lower than  $R_{MAX}$**  (see Table2), upper to set limit value **and the instrument generated the Nominal test Voltage**, the instrument emits a **double sound signal indicating the positive outcome of the test** and displays one screen similar to the screen alongside.

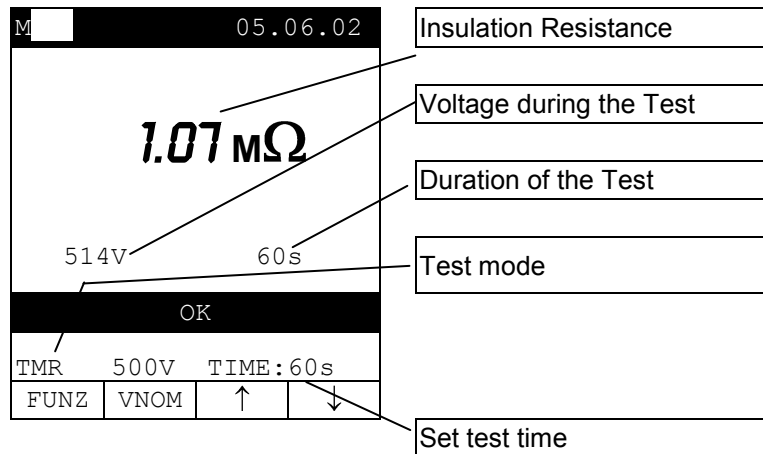

The displayed result can be stored pressing the **SAVE** key **twice** (according to paragraph 9.1).

☞ If the Insulation resistance is **higher than  $R_{MAX}$**  (see Table2), the instrument emits a **double sound signal** at the end of the test **indicating the positive outcome of the test** and displays one screen similar to the screen alongside.

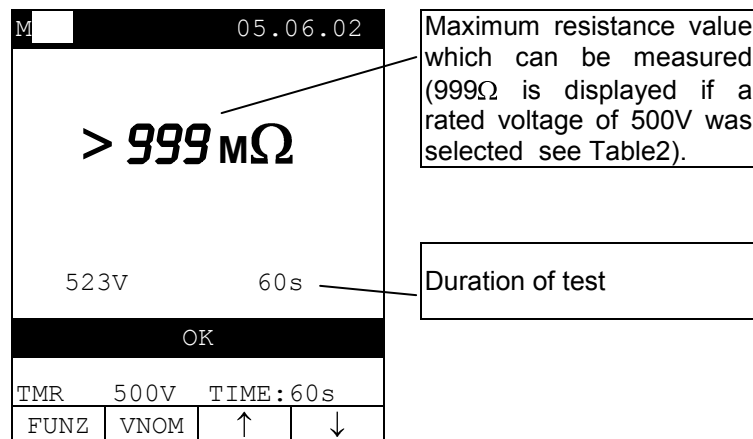

The displayed result can be stored pressing the **SAVE** key **twice** (according to paragraph 9.1).

### 6.2.4. "MAN" and "TIMER" mode faulty cases

☞ If the instrument detect the External Power supply adapter connected to instrument will show the message displayed to side.

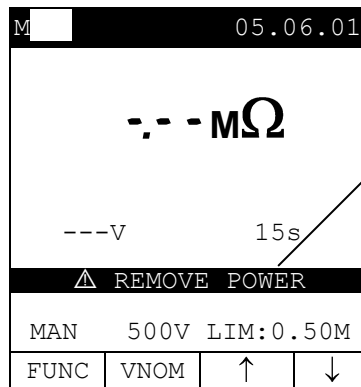

Disconnect the External Power Supply Adapter

☞ If the instrument detect a Voltage between Input terminals higher than 15V, the instrument does not effect the test and displays the screen alongside for 5 seconds.

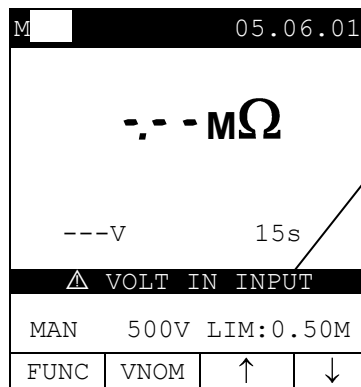

**ATTENTION:** the test can't be executed. Check that the circuit is not energised.

### THE PREVIOUS RESULTS CAN'T BE SAVED

☞ If the instrument can't generate the Nominal Test Voltage it will emits a **long acoustic signal** and displays a screen similar to the screen alongside.

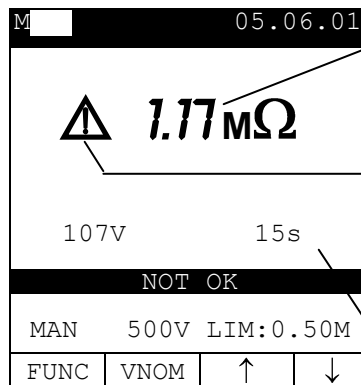

Insulation Resistance

**ATTENTION:** the test of resistance  $R_{ISO}$  was effected at a voltage value lower than the set rated voltage. Low insulation case. This case occurs under low insulation conditions or in the presence of capacity on the installation.

Test Time

☞ If the instrument perform a test with a test voltage higher than Nominal Test Voltage and the measured result is lower than set limit, it will emits a **long acoustic signal** and displays a screen similar to the screen alongside.

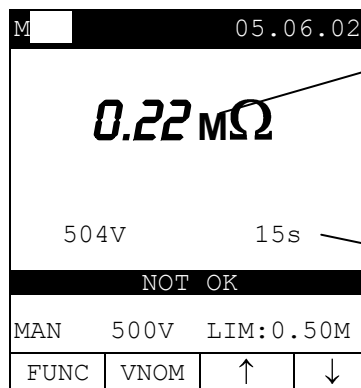

Insulation Resistance

Duration of Test

Set limit value



The displayed result can be stored pressing the **SAVE** key **twice** (according to paragraph 9.1).

### 6.3. RCD: TEST ON "A" AND "AC" RCDS TYPE

#### WARNING



The automatic check of the RCD features causes the tripping of the RCD itself. Therefore **check that all devices connected downstream the RCD under test are not damaged by power off**. Possibly disconnect all the loads connected downstream the RCD as they could add additional leakage currents to the instrument ones and so making the test results void.

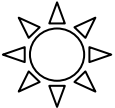

Turn the **switch** on **RCD** position:

#### F1

The **F1** key permits to select one of the following measuring mode (which can be shown cyclically when pressing the key):

- ☞ Mode "**AUTO**" (the instrument effects the test automatically with a leakage current equal to half, once and five times the value of the rated current set). Recommended test.
- ☞ Mode "**x 1/2**" (the instrument effects the test with a leakage current equal to half the value of the rated current set).
- ☞ Mode "**x 1**" (the instrument effects the test with a leakage current equal to once the value of the rated current set).
- ☞ Mode "**x 2**" (the instrument effects the test with a leakage current equal to twice the value of the rated current set).
- ☞ Mode "**x 5**" (the instrument effects the test with a leakage current equal to five times the value of the rated current).
- ☞ Mode "**▲**" (the instrument effects the test with a ramp growing leakage current. Use this test to measure the tripping current).
- ☞ Mode "**R<sub>A</sub>⊥**" (the instrument effects the test with a leakage current equal to half the value of the selected rated current and calculates the contact voltage as well as the R<sub>a</sub> earth resistance).

**N.B.** The **AUTO** mode execute automatically test with phase 0° and 180°

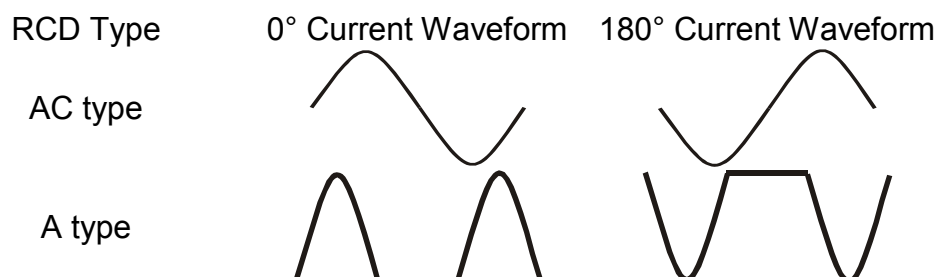

According to standard praxis it is recommended to effect RCD test both with phase 0° and with phase 180° even with no AUTO modes. If the RCD under test is A type (which means sensitive to both AC and unidirectional pulsing leakage currents) it is advisable to effect the test both with sine wave and unidirectional pulse current with phase 0° and 180°.

**F2**

The **F2** key permits to select one of the following rated tripping currents of the RCD (which can be shown cyclically when pressing the key):

- ☞ 10mA.
- ☞ 30mA.
- ☞ 100mA.
- ☞ 300mA.
- ☞ 500mA.

**F3**

The **F3** key permits to select the RCD type (which can be shown cyclically when pressing the key):

- ☞ "⋈": general RCD AC type (sensitive to sine leakage current)
- ☞ "⋈": general RCD A type (sensitive to pulsating leakage current)
- ☞ "⋈**S**": selective RCD AC type (sensitive to sine leakage current)
- ☞ "⋈**S**": selective RCD A type (sensitive to pulsating leakage current)

**Note** if the test is effected on **general RCDs** the symbol **S** is NOT displayed

**Note** the test on the selective RCDs requires an interval between the tests of 60 seconds (30 seconds in case of tests at  $\frac{1}{2} I_{\Delta n}$ ). A timer is displayed indicating the waiting time for each step.

**Example:** Test with AUTO mode on a RCD with  $I_{\Delta n}=30\text{mA}$ .

- a) the instrument effects the test at  $\frac{1}{2} I_{\Delta n} 0^\circ$ . The RCD must not trip.
- b) The instrument effects the test at  $\frac{1}{2} I_{\Delta n} 180^\circ$ . The RCD must not trip. For a Selective RCD a 30 seconds timer starts before executing next test.
- c) The instrument effects the test at  $I_{\Delta n} 0^\circ$ . If the RCD passed the test, it must trip and the instrument shows the message "RESUME RCD". The operator shall resume the RCD. For a Selective RCD a 60 seconds timer starts before executing next test.
- d) The instrument effects the test at  $I_{\Delta n} 180^\circ$ . Follow the same procedure as described under c).
- e) The instrument effects the test at  $5I_{\Delta n} 0^\circ$ . Follow the same procedure as described under c).
- f) The instrument effects the test at  $5I_{\Delta n} 180^\circ$ . Follow the same procedure as described under c). The test is completed.

**F4**

The **F4** key permits to select one of the following **limit values for the contact voltage** (which can be shown cyclically when pressing the key):

- ☞ 50V (default)
- ☞ 25V.

### 6.3.1. Tripping times for the general and selective RCDs

☞ **Table of tripping times for  $I_{\Delta N} \times 1$ ,  $I_{\Delta N} \times 2$ ,  $I_{\Delta N} \times 5$  and AUTO tests.**

If the parameters set on the instrument comply with the type of RCD under test (and if the latter works properly) the test **x1**, **x2**, **x5** **SHALL** cause the RCD tripping within the times shown in the following table:

RCD type	$I_{\Delta N} \times 1$	$I_{\Delta N} \times 2$	$I_{\Delta N} \times 5$	Description
General	0.3s	0.15s	0.04s	<b>Max</b> tripping time in seconds
Selective <b>S</b>	0.5s	0.20s	0.15s	<b>Max</b> tripping time in seconds
	0.13s	0.05s	0.05s	<b>Minimum</b> tripping time in seconds

\* For rated values  $I_{\Delta N} \leq 30\text{mA}$  the test current at five times is 0.25A.  
For currents equal to  $\frac{1}{2} I_{\Delta N}$  the RCD shall not trip in any case.

Table 3: Table of tripping times for tests with leakage currents  $I_{\Delta N} \times 1$ ,  $I_{\Delta N} \times 2$ ,  $I_{\Delta N} \times 5$  and AUTO.

☞ **Table of tripping times for ramp tests "▲".**

This test is not used to be effected to compare the RCD tripping time at the tripping current, while the standards refer to the maximum tripping times in case the RCD is checked with a leakage current equal to the rated current.

The limits value for the tripping current are indicated in the following Table:

RCD Type	$I_{\Delta N} \leq 10\text{mA}$	$I_{\Delta N} > 10\text{mA}$
A	$1,4 \times I_{\Delta N}$	$1,4 \times I_{\Delta N}$
AC	$I_{\Delta N}$	$I_{\Delta N}$

Table 4: Current limit value for "Ramp" Test

### 6.3.2. Measurement procedure



1. Select the desired test parameter by means of the **F1**, **F2**, **F3**, **F4** key.
2. Connect the Black, Green and Blue connectors of the three-terminal shuko cable or of the split cables to the corresponding input terminals of the instrument **B1**, **B3**, **B4**

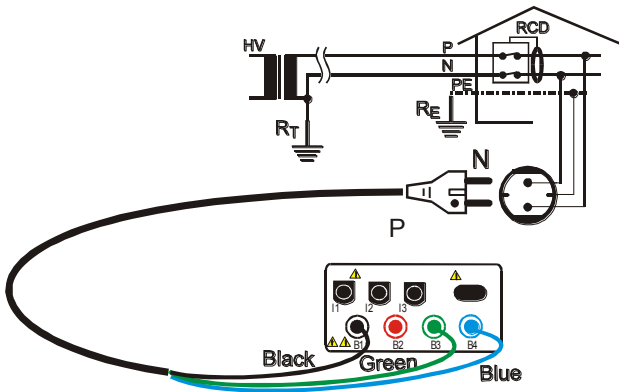

Instrument connection for 230V single-phase RCD check

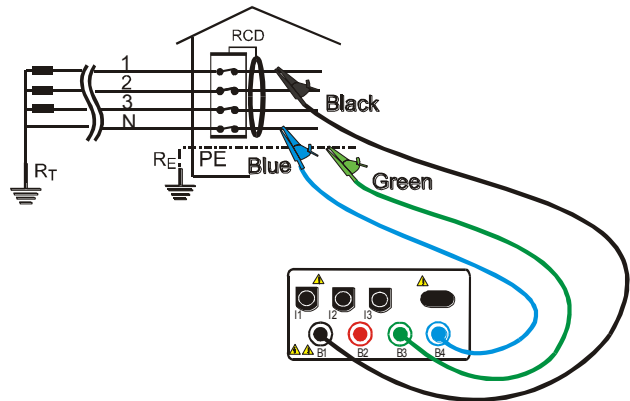

Instrument connection for 400V + N + PE three-phase RCD check

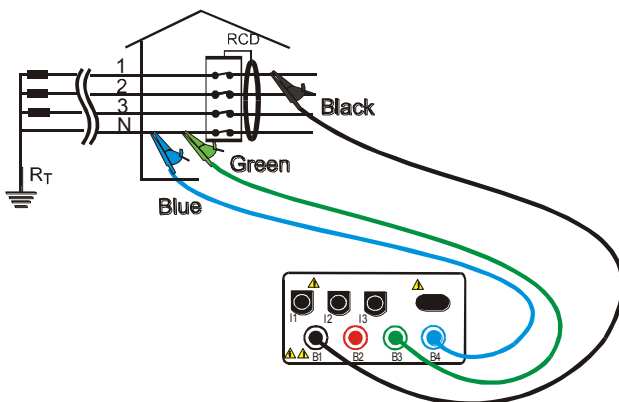

Instrument connection for 400V + N (no PE) three-phase RCD check

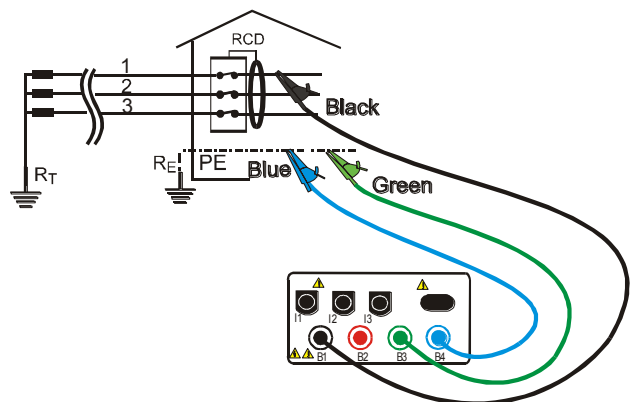

Instrument connection for 400V + PE (no N) three-phase RCD check

3. Connect the shuko plug or the Test leads to the System under test according with one of the picture above.

### 6.3.2.1. Results of "x1/2" mode



4. Press the **START** key **once** to execute a test with 0° Current waveform.

or

Press the **START** key **twice** to execute a test with 180° Current waveform.

## WARNING



Never disconnect the test leads from the circuit under test when the message "**MEASURING**" is displayed.

☞ If the RCD **does NOT trip** the instrument emits a **double sound signal indicating the positive outcome** of the test and displays the screen alongside.

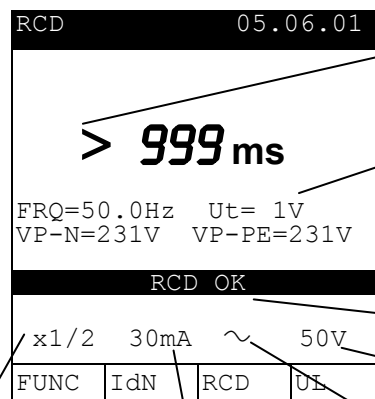

The symbol ">" means that the RCD did not trip.

Value of contact voltage  $U_t$  detected referred to the rated value of the RCD current set.

**OK:** RCD passed the test.

Contact Voltage Limit value

Working mode

RCD nominal current

RCD type



5. The test can be stored pressing the **SAVE** key **twice** (according to paragraph 9.1).



### 6.3.2.2. Results of "x1, x2, x5" mode



4. Press the **START** key **once** to execute a test with 0° Current waveform.

or

Press the **START** key **twice** to execute a test with 180° Current waveform.

**WARNING**

Never disconnect the test leads from the circuit under test when the message "**MEASURING**" is displayed.

☞ If the tripping time is within the limits reported in Table 3, the instrument emits a **double sound signal indicating the positive outcome** of the test and displays the screen alongside.

Working mode

RCD

05.06.01

Tripping time (expressed in milliseconds).

49 ms

FRQ=50.0Hz Ut= 2V  
VP-N=231V VP-PE=231V

RCD OK

OK: RCD passed the test.

x1

30mA

~

50V

Contact Voltage Limit value

FUNC

IdN

RCD

UL

RCD nominal current

RCD type



5. The test can be stored pressing the **SAVE** key **twice** (according to paragraph 9.1).

### 6.3.2.3. Results of "AUTO" mode



4. Press the **START** key **once** to execute the test. The instrument carries out the following six tests with different values of rated current:
  - ☞  $1/2I_{\Delta n}$  with  $0^\circ$  current waveform (the RCD shall not trip).
  - ☞  $1/2I_{\Delta n}$  with  $180^\circ$  current waveform (the RCD shall not trip).
  - ☞  $I_{\Delta n}$  with  $0^\circ$  current waveform (the RCD trips, message "**RESUME RCD**").
  - ☞  $I_{\Delta n}$  with  $180^\circ$  current waveform (the RCD trips, message "**RESUME RCD**").
  - ☞  $5I_{\Delta n}$  with  $0^\circ$  current waveform (the RCD trips, message "**RESUME RCD**").
  - ☞  $5I_{\Delta n}$  with  $180^\circ$  current waveform (the RCD trips, end of the test).

The test is good if all values of tripping times are within the limits reported in Table 3.

### WARNING



Never disconnect the test leads from the circuit under test when the message "**MEASURING**" is displayed.

☞ At the end of the test if **all six tests resulted to be positive**, the instrument displays the screen alongside relative to the last measurement effected.

RCD		05.06.01	
	$0^\circ$	$180^\circ$	
x1/2	>999ms	>999ms	
x1	55ms	65ms	
x5	20ms	30ms	
FRQ=50.0Hz		Ut= 1V	
VP-N=231V		VP-PE=231V	
RCD OK			
AUTO	30mA	~	50V
FUNC	IdN	RCD	UL

Tripping time (expressed in milliseconds).

Value of contact voltage  $U_t$  detected referred to the rated value of the RCD current set.

**OK:** RCD passed the test.

Contact Voltage Limit value

Working mode

RCD nominal current

RCD type



5. The test can be stored pressing the **SAVE** key **twice** (according to paragraph 9.1).

### 6.3.2.4. Results of "RAMP " mode



4. Press the **START** key **once** to execute a test with 0° Current waveform.

or

Press the **START** key **twice** to execute a test with 180° Current waveform.

The instrument generates a leakage current growing step by step for a given time interval.

## WARNING



Never disconnect the test leads from the circuit under test when the message "**MEASURING**" is displayed.

At the end of the test if the RCD tripping current is lower than  $I_{\Delta n}$  (Type AC) or  $1.4I_{\Delta n}$  (Type A with  $I_{\Delta n} > 10\text{mA}$ ) or  $2I_{\Delta n}$  (Type A with  $I_{\Delta n} \leq 10\text{mA}$ ), the instrument emits a double sound signal indicating the positive outcome of the test and displays the screen alongside.

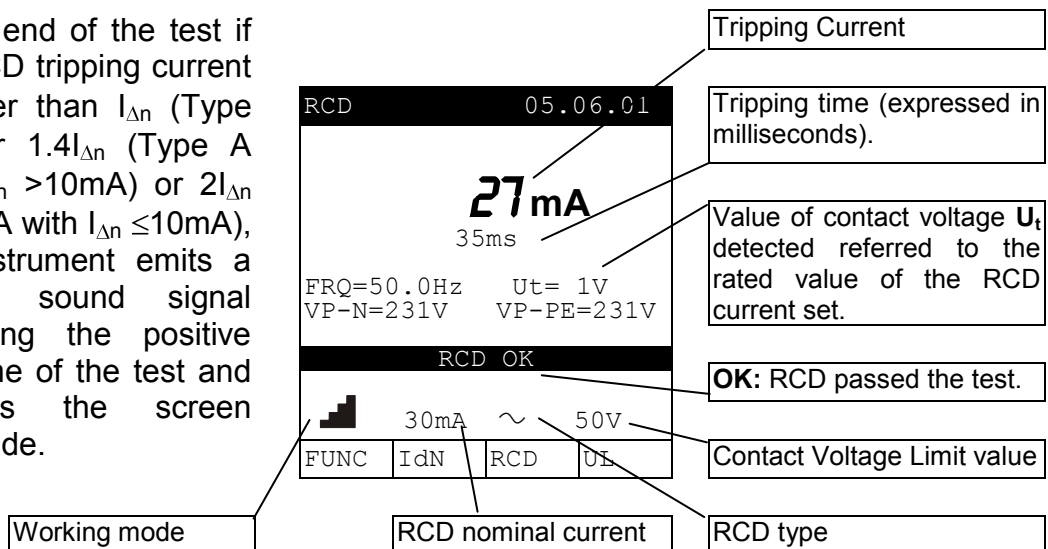

5. The test can be stored pressing the **SAVE** key **twice** (according to paragraph 9.1).

### 6.3.2.5. Results of "R<sub>A</sub>⏚" mode



4. Press the **START** key **once**: the instrument carries out the test.



#### WARNING

Never disconnect the test leads from the circuit under test when the message "**MEASURING**" is displayed.

- ☞ The RCD **must NOT trip** and the instrument emits a **double sound signal** indicating the **positive outcome** of the test and displays the screen alongside.

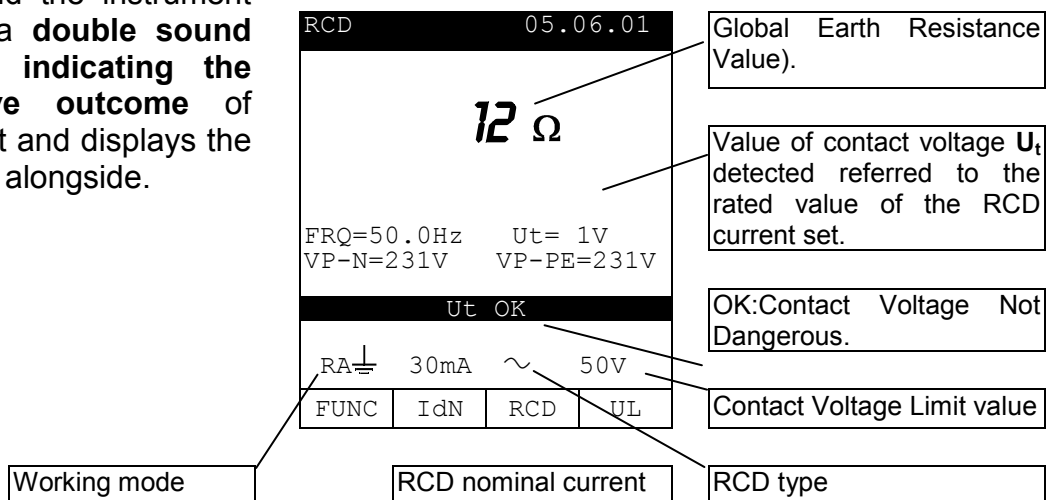

5. The test can be stored pressing the **SAVE** key **twice** (according to paragraph 9.1).

### 6.3.3. RCD Faulty cases

#### 6.3.3.1. Connection troubles

☞ If the instrument detect the External Power supply adapter connected to instrument will show the message displayed to side.

RCD		05.06.01	
- - - ms			
FRQ=50.0Hz	Ut= ---V		
VP-N=230V	Vp-PE=230V		
⚠ REMOVE POWER			
x1	30mA	~	50V
FUNC	IdN	RCD	UL

Disconnect the External Power Supply Adapter

☞ Should the instrument detect that the phase and/or neutral cables are not connected to an installation, screen alongside is displayed when pressing **START**.

RCD		05.06.01	
- - - ms			
FRQ=50.0Hz	Ut= ---V		
VP-N= 0V	Vp-PE= 0V		
⚠ LOW VOLTAGE			
x1	30mA	~	50V
FUNC	IdN	RCD	UL

NO VOLTAGE Detected

☞ Should the instrument detect a voltage between phase and neutral higher of 265V, for example in case the blue cable is connected to an installation phase conductor of a 400V three-phase system, the screen alongside is displayed.

RCD		05.06.01	
- - - ms			
FRQ=50.0Hz	Ut= ---V		
VP-N=401V	VP-PE= 230V		
⚠ HIGH VOLTAGE			
x1	30mA	~	50V
FUNC	IdN	RCD	UL

HIGH VOLTAGE Detected

☞ This screen is displayed when the phase conductor has been exchanged with the neutral one. The instrument does not effect the test. Reverse the shuko plug or exchange the black cable with the blue one. Repeat the test

RCD		05.06.01	
- - - ms			
FRQ=50.0Hz	Ut= ---V		
VP-N=231V	VP-PE= 0V		
⚠ CHANGE P-N			
x1	30mA	~	50V
FUNC	IdN	RCD	UL

Phase and Neutral are exchanged.

☞ This screen is displayed when the phase conductor has been exchanged with the Protection Conductors. The instrument does not effect the test. Reverse the phase to earth connection in the plug or exchange the black cable with the green one

RCD		05.06.01	
- - - ms			
FRQ=50.0Hz		Ut= ---V	
VP-N= 2V		VP-PE= 230V	
△ CHANGE P-PE			
x1	30mA	~	50V
FUNC	IdN	RCD	UL

Phase and Protection Conductors are exchanged.

☞ This screen is displayed when in a 230V Phase to Phase System the blue conductor was reversed with respect to the green one. The instrument does not effect the test. Reverse the blue and green conductors.

RCD		05.06.01	
- - - ms			
FRQ=50.0Hz		Ut= ---V	
VP-N=130V		VP-PE= 227V	
△ CHANGE N-PE			
x1	30mA	~	50V
FUNC	IdN	RCD	UL

Neutral and Protection Conductors are exchanged.

☞ If a contact voltage  $U_t$  higher than the selected limit ( $U_L$ ) is detected, the instrument interrupts the test and emits a long sound signal at the end of the test and displays the screen alongside.

RCD		05.06.01	
- - - ms			
FRQ=50.0Hz		Ut= ---V	
VP-N=234V		VP-PE= 234V	
△ UT DANGEROUS			
x1	30mA	~	50V
FUNC	IdN	RCD	UL

The instrument doesn't detect an efficient protection circuit.

☞ If the instrument detects that the earth cable (green) is not connected, the screen alongside is displayed for 5 seconds then the initial display is back. Check the connections of PE conductor under test.

RCD		05.06.01	
- - - ms			
FRQ =50.0Hz		Ut= ---V	
VP-N=234V		VP-PE= 34V	
△ NO PE			
x1	30mA	~	50V
FUNC	IdN	RCD	UL

Message "NO PE": the instrument doesn't detect an efficient protection circuit.

☞ If the instrument gets overheated, tests cannot be carried out and the message alongside is displayed. Wait until the initial screen is back in order to proceed with measurements.

RCD		05.06.01	
- - - ms			
FRQ=50.0Hz		Ut= ---V	
VP-N=231V		VP-PE= 230V	
△ HOT			
x1	500mA	~	50V
FUNC	IdN	RCD	UL

Message "hot": the instrument got overheated.

### THE PREVIOUS RESULTS CANNOT BE SAVED.

☞ Using the  $R_A \perp$  function, if a contact voltage  $U_t$  **higher than the selected limit ( $U_L$ )** is detected the instrument emits a long sound signal at the end of the test and displays the screen alongside.

RCD		05.06.01	
1800Ω			
FRQ=50.0Hz		Ut= 54V	
VP-N=234V		VP-PE= 34V	
△ UT NOT OK			
$R_A \perp$	30mA	~	50V
FUNC	IdN	RCD	UL

The instrument doesn't detect an efficient protection circuit.



The test can be stored pressing the **SAVE** key **twice** (according to paragraph 9.1).

### 6.3.3.2. RCD tripping "faulty cases"

☞ If the RCD trips during the preliminary test performed before the test (independently from the working mode) the instrument displays the screen alongside.

RCD		05.06.01	
- - - ms			
FRQ=50.0Hz		Ut= ---V	
VP-N=231V		VP-PE= 230V	
△ RCD TRIPS			
x1	30mA	~	50V
FUNC	IdN	RCD	UL

The RCD trips too early. Check if the RCD Nominal Current is correct. Some leakage currents may be present in the installation. Disconnect all the loads connected downstream the RCD.

### THE PREVIOUS RESULTS CANNOT BE SAVED.

☞ In the tests MAN x1, x2, x5 and AUTO (during x1 and x5 tests), if the RCD trips to separate the circuit within a time not complying with the limits reported in Table 3, the instrument emits a **long acoustic signal** at the end of the test and displays the values alongside.

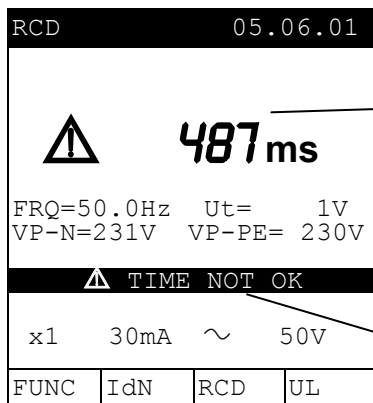

RCD tripping time.

**ATTENTION:** the tripping time is higher than the standard limit.

☞ If the RCD tripping time is higher than the instrument's measuring limits, the instrument emits a **long sound signal** at the end of the test and displays the values alongside.

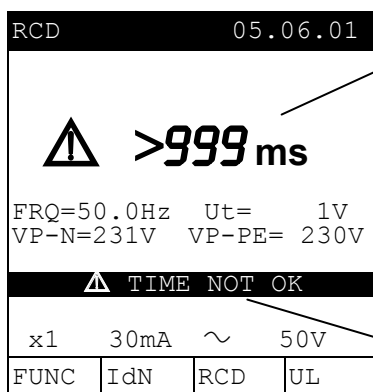

RCD tripping time is bigger than the maximum measurable time (it depends on type of test, see following table).

**ATTENTION:** the tripping time is higher than the standard limit.

The maximum duration depends on the test type:

Test type	General RCD	Selective RCD
MAN x1 test	999ms	999ms
MAN x2 test	200ms	250ms
MAN x5 test	50ms	160ms
"▬" test	300ms	

Table 5: maximum duration of Tests on RCDs

☞ During the ramp **▬** test if the RCD tripping time is higher than the limit, the instrument emits a **long sound signal** at the end of the test and displays the values alongside.

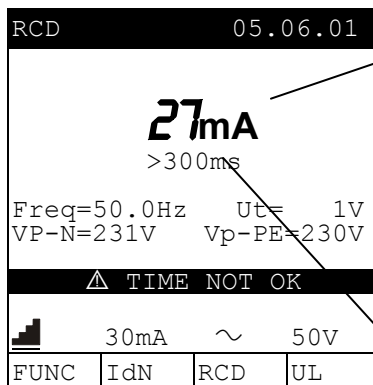

Tripping Current.

Tripping Time exceeding limit value



The previous tests can be stored pressing the **SAVE** key **twice** (according to paragraph 9.1).



During the **ramp** test if the RCD tripping current is higher than  $I_{\Delta n}$  (Type AC) or  $1.4 I_{\Delta n}$  (Type A with  $I_{\Delta n} > 10\text{mA}$ ) or  $2 I_{\Delta n}$  (Type A with  $I_{\Delta n} \leq 10\text{mA}$ ), the instrument emits a **long sound signal** at the end of the test and displays the values alongside.

RCD		05.06.01	
<b>&gt; 42mA</b> >300ms			
FRQ=50.0Hz		Ut= 1V	
VP-N=231V		VP-PE=230V	
CURRENT NOT OK			
30mA		50V	
FUNC	IdN	RCD	UL

Maximum current generated by the instrument during the test for general RCDs (the value indicated is referred to an AC type 30mA RCD, in this case the maximum current supplied is equal to  $1.4 I_{\Delta n}$

**ATTENTION:**  
 the RCD tripping current is higher than the Nominal Value ( $I_{\Delta n}=30\text{mA}$  was set in the example).



The test can be stored pressing the **SAVE** key **twice** (according to paragraph 9.1).

## 6.4. LOOP : MEASUREMENT OF LINE IMPEDANCE, FAULT LOOP IMPEDANCE, PROSPECTIVE SHORT CIRCUIT CURRENT CALCULATION AND PHASE SEQUENCE INDICATOR

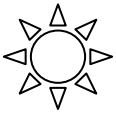

Turn the **switch** on **LOOP**  position.

**F1**

The **F1** key permits to select one of the following measuring modes:

- ☞ Mode "**P-N**" (the instrument measures the impedance between the phase and neutral conductors and calculates the phase to neutral prospective short circuit current).
- ☞ Mode "**P-P**" (the instrument measures the impedance between two phase conductors and calculates the phase to phase prospective short circuit current).
- ☞ Mode "**P-PE**" (the instrument measures the impedance between the phase and protective conductors and calculates the phase to earth prospective short circuit current).
- ☞ Mode "**R<sub>A</sub>≡**" (the instrument measures the impedance between the phase and protective conductors with a test current of 15mA in order to avoid RCD tripping and calculates the phase to earth prospective short circuit current).
- ☞ Mode "" (the instrument detect the Phase Sequence in a three-phase system).

### WARNING



Never disconnect the test leads from the circuit under test when the message "**MEASURING**" is displayed.

### 6.4.1. High resolution Impedance measurement (0.1mΩ)

The GSC53N, GSC57 and ZG47 models can be connected to an external **optional** accessory (**IMP57**) capable of measuring high resolution impedance close to a power transformer.

The high Resolution impedance measurement is available inside the **LOOP P-P, P-N, P-PE** modes by mean **Un/Δn** key. If You enable the High Resolution Impedance Measurement mode without connecting IMP57 the following screen will be displayed (e.g.: Loop P-N):

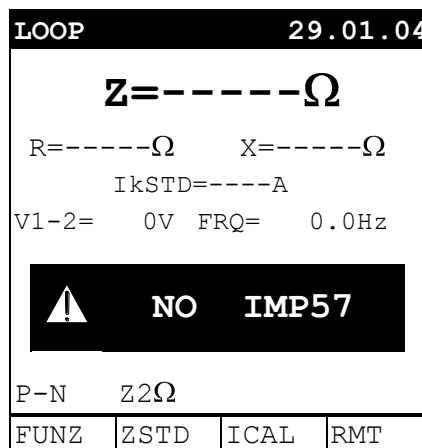

For further details regarding IMP57 use and technical characteristics please refer to IMP57 user's manual or HT web site [www.htitalia.com](http://www.htitalia.com).

### 6.4.2. Measurement procedure and results of "P-N" mode

**F1**

1. Select **P-N** mode by means of the **F1** key.
2. Connect the Black, Green and Blue connectors of the three-terminal shuko cable or of the split cables to the corresponding input terminals of the instrument **B1**, **B3**, **B4**

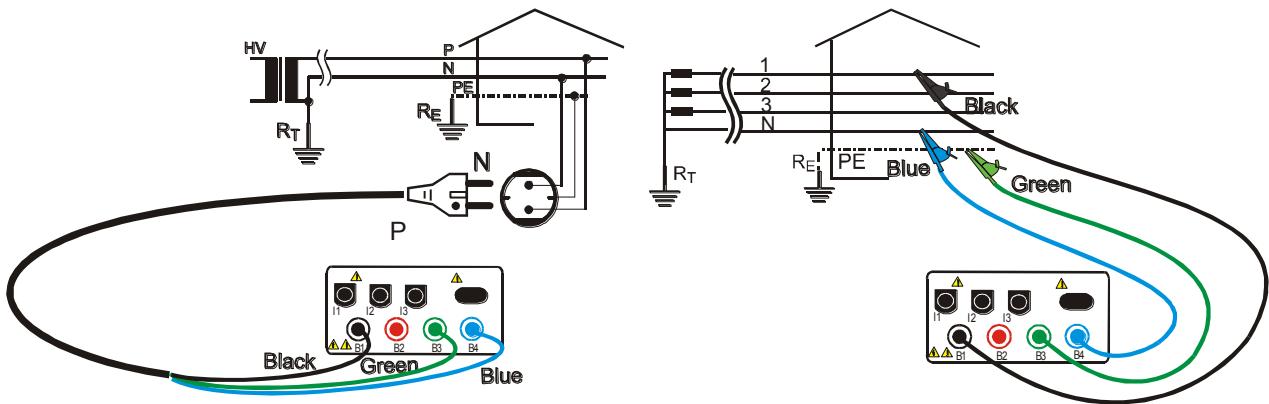

Instrument connection for P-N test in a 230V single-phase System

Instrument connection for P-N in a 400V three-phase system

3. Connect the shuko plug into a 230V 50Hz socket or the crocodiles to the conductors of the three-phase system (see previous pictures).
4. If possible disconnect all low impedance loads downstream the point at which the measurement is to be taken, as such impedances would be in parallel with the line impedance to be measured.
5. Press the **START** key. The instrument starts the test.

**START STOP**

### WARNING



The measurement in a 230V System make flow a test current of 6A approx. This may cause the tripping of magnetic protection switch with nominal value lower than 10A. If necessary effect the test upstream the switch.

At the end of the test the instrument emits a **double sound signal indicating that the test is correctly terminated** and displays the values alongside.

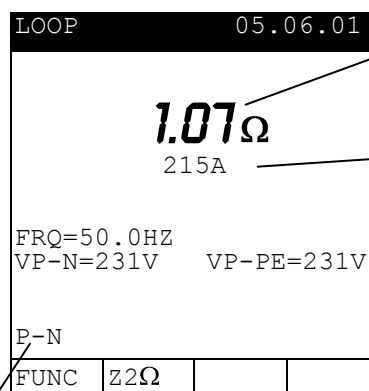

Value of phase to neutral line impedance expressed in Ω.

Value of the phase to neutral prospective short circuit current expressed in Ampere calculated according to the following formula.

Working mode

### WARNING



Never disconnect the test leads from the circuit under test when the message "**MEASURING**" is displayed.

Formula for calculation of prospective short circuit current:

$$I_{CC} = \frac{U_N}{Z_{PN}}$$

where  $U_N$  = Nominal phase to neutral voltage =  $\begin{matrix} 127 \text{ if } V_{\text{meas}} \leq 150 \\ 230 \text{ if } 150V < V_{\text{meas}} \leq 250 \end{matrix}$



This result can be stored pressing the **SAVE** key **twice** (according to paragraph 9.1).

### 6.4.3. Measurement procedure and results of "P-P" mode

- F1**
1. Select **P-P** mode by means of the **F1** key.
  2. Connect the Black, Green and Blue connectors of the three-terminal shuko cable or of the split cables to the corresponding input terminals of the instrument **B1**, **B3**, **B4**

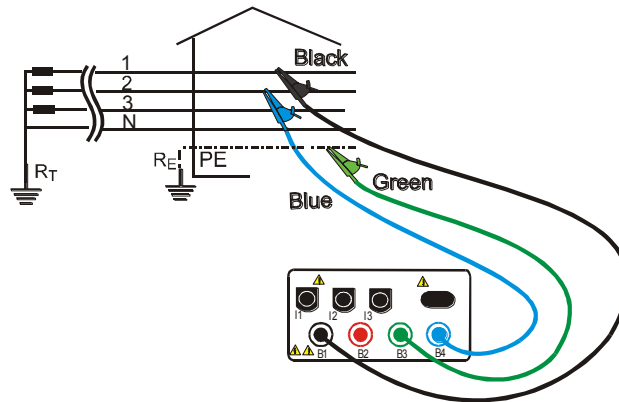

Instrument connection for P-P test in a 400V three-phase system

3. Connect the shuko plug into a 230V 50Hz socket or the crocodiles to the conductors of the three-phase system (see previous pictures).
4. If possible disconnect all low impedance loads downstream the point at which the measurement is to be taken, as such impedance would be in parallel with the line impedance to be measured.
5. Press the **START** key. The instrument starts the test.



## WARNING



The P-P measurement in a 400V system make flow a test current of 11.5A approx. This may cause the tripping of magnetic protection switch with nominal value lower than 10A. If necessary effect the test upstream the switch.

At the end of the test the instrument emits a **double sound signal** indicating that the test is **correctly terminated** and displays the values alongside.

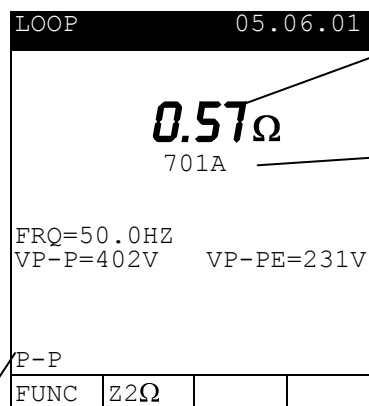

Value of phase to phase impedance expressed in  $\Omega$ .

Value of the phase to phase prospective short circuit current expressed in Ampere calculated according to the following formula.

Working mode

## WARNING



Never disconnect the test leads from the circuit under test when the message "**MEASURING**" is displayed.

Formula for calculation of prospective short circuit current:

$$I_{CC} = \frac{U_N}{Z_{PN}}$$

where  $U_N$  = phase to phase voltage

127 if  $V_{meas} \leq 150$   
 230 if  $150V < V_{meas} \leq 260$   
 400 if  $V_{meas} > 260$



This result can be stored pressing the **SAVE** key **twice** (according to paragraph 9.1).

#### 6.4.4. Measurement procedure and results of "P-PE" mode

**F1**

1. Select **P-PE** mode by means of the **F1** key.
2. Connect the Black, Green and Blue connectors of the three-terminal shuko cable or of the split cables to the corresponding input terminals of the instrument **B1**, **B3**, **B4**.

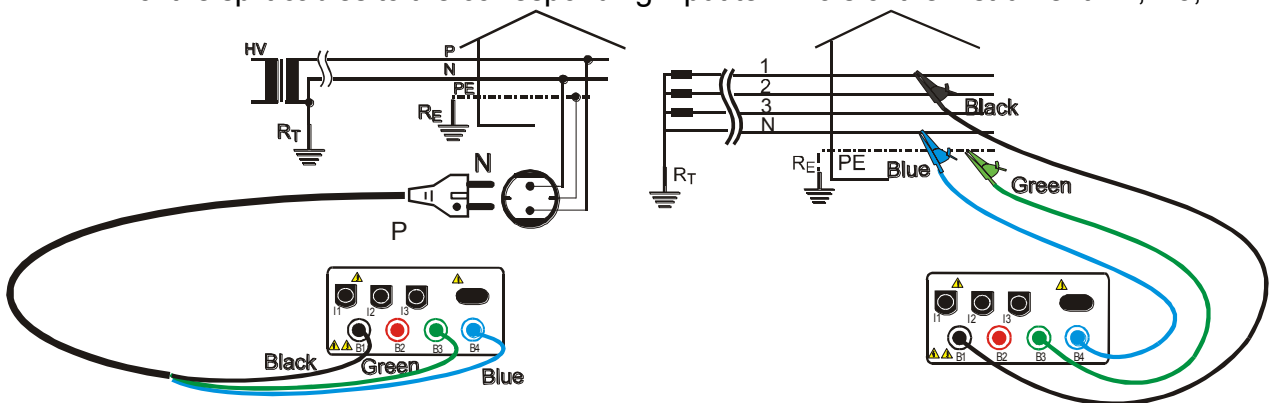

Instrument connection for P-PE test in a 230V single-phase System

Instrument connection for P-PE in a 400V three-phase system

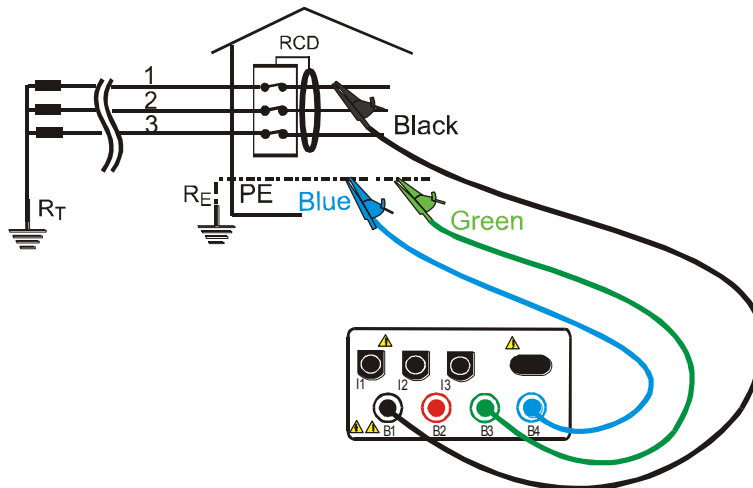

Instrument connection for P-PE in a 400V three-phase system without Neutral conductor

3. Connect the shuko plug into a 230V 50Hz socket or the crocodiles to the conductors of the three-phase system (see previous pictures).
4. The key **F4** permits to select one of the following **limit values for the contact voltage** (which can be shown cyclically when pressing the key):
  - ☞ 50V (default).
  - ☞ 25V.
5. Press the **START** key **once** to execute a test injecting a current in phase with positive half wave of the voltage.  
Press the **START** key **twice** to execute a test injecting a current in phase with negative half wave of the voltage.



### WARNING



The P-PE measurement in a 230V System make flow a test current of 6A approx. This may cause the tripping of magnetic protection switch with nominal value lower than 10A and **will cause the tripping of RCD device**. If necessary effect the test upstream the switch or RCD.

☞ At the end of the test the instrument emits a **double sound signal indicating that the test is correctly terminated** and displays the values alongside.

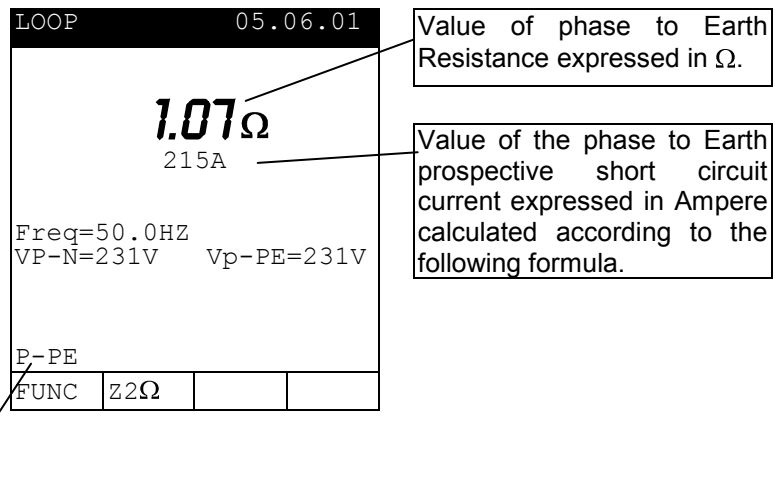

**WARNING**

Never disconnect the test leads from the circuit under test when the message "**MEASURING**" is displayed.

Formula for calculation of prospective short circuit current:

$$I_{CC} = \frac{U_N}{Z_{PN}}$$

where  $U_N$  = Nominal phase to neutral voltage = 127 if  $V_{meas} \leq 150$   
230 if  $150V < V_{meas} \leq 250$



This result can be stored pressing the **SAVE** key **twice** (according to paragraph 9.1).



### 6.4.5. Measurement procedure and results of " $R_{A\perp}$ " mode

- F1**
1. Select  $R_{A\perp}$  mode by means of the **F1** key.
  2. Connect the Black, Green and Blue connectors of the three-terminal shuko cable or of the split cables to the corresponding input terminals of the instrument **B1**, **B3**, **B4**.

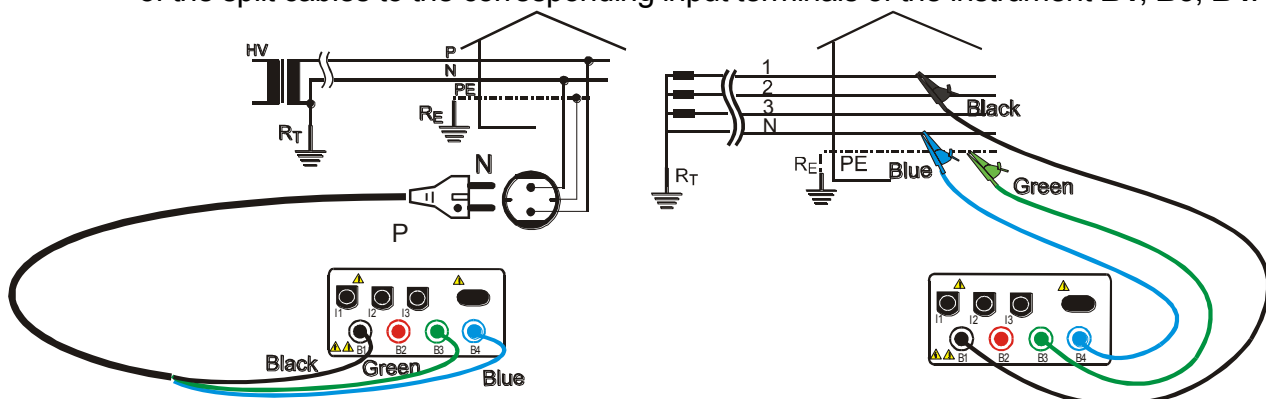

Instrument connection for P-PE test in a 230V single-phase System

Instrument connection for P-PE in a 400V three-phase system

3. Connect the shuko plug into a 230V 50Hz socket or the crocodiles to the conductors of the three-phase system (see previous pictures).
  4. If possible disconnect all low impedance loads downstream the point at which the measurement is to be taken, as such impedance would be in parallel with the line impedance to be measured.
  5. The key **F4** permits to select one of the following **limit values for the contact voltage** (which can be shown cyclically when pressing the key):
    - ☞ 50V (default)
    - ☞ 25V.
- START STOP**
6. Press the **START** key to execute a test.

#### WARNING



The  $R_{A\perp}$  measurement make flow a test current of 15mA. This may cause tripping of 10mA. If necessary effect the test upstream the switch.

#### WARNING



Never disconnect the test leads from the circuit under test when the message "**MEASURING**" is displayed.

At the end of the test the instrument emits a **double sound signal indicating that the test is correctly terminated** and displays the values alongside.

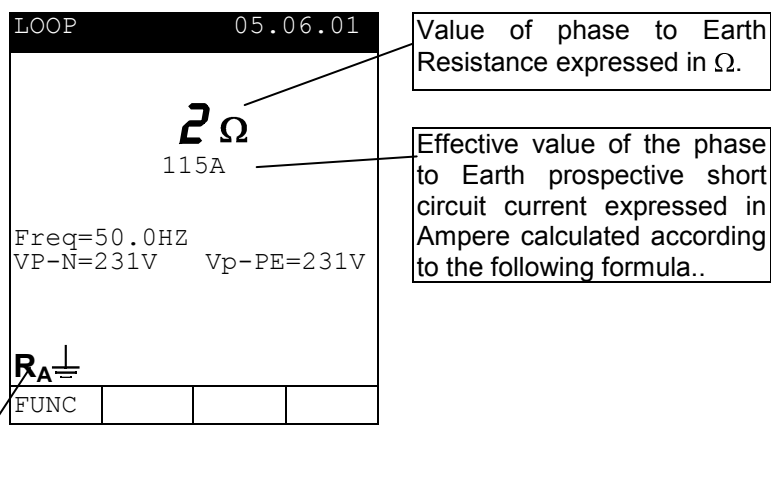

Formula for calculation of prospective short circuit current:

$$I_{CC} = \frac{U_N}{Z_{PN}}$$

where  $U_N$  = Nominal phase to neutral voltage =  $\begin{matrix} 127 & \text{if } V_{\text{meas}} \leq 150 \\ 230 & \text{if } 150V < V_{\text{meas}} \leq 250 \end{matrix}$



This result can be stored pressing the **SAVE** key **twice** (according to paragraph 9.1).

### 6.4.6. Measurement procedure and results of "↻" mode

- F1**
1. Select ↻ mode by means of the **F1** key.
  2. Connect the Black, Red and Green connectors of the split cables to the corresponding input terminals of the instrument **B1**, **B2**, **B3**.

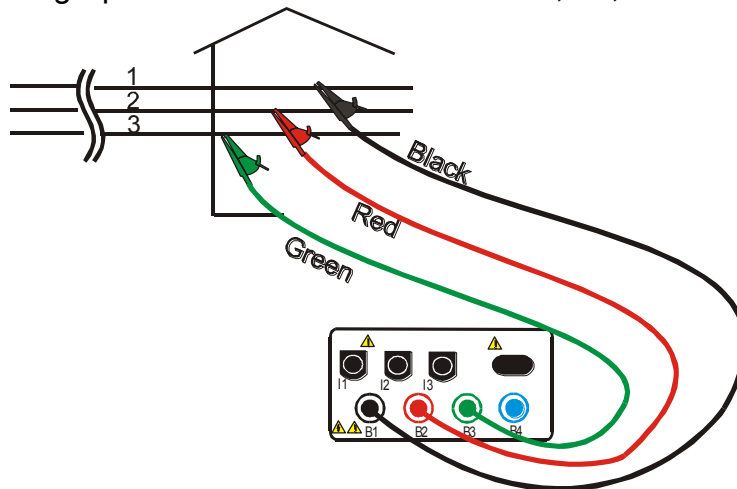

Instrument connection for Phase Sequence Detection in a 400V three-phase system

3. Press the **START** key to execute a test.

☞ At the end of the test the instrument emits a **double sound signal** indicating that the test is **correctly terminated** and displays the values alongside.

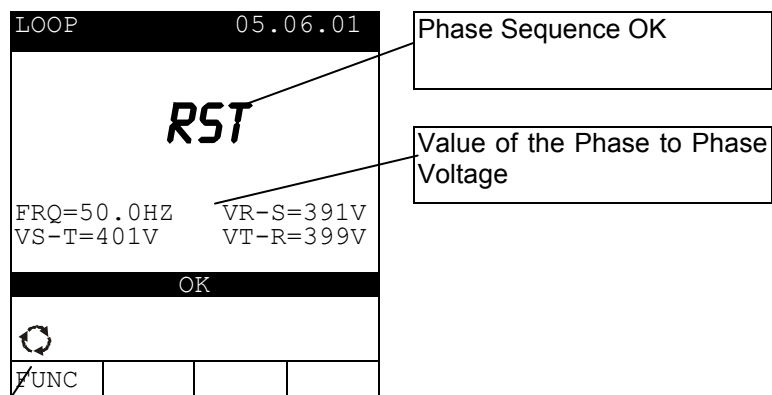

Phase Sequence OK

Value of the Phase to Phase Voltage

Working mode



This result can be stored pressing the **SAVE** key **twice** (according to paragraph 9.1).

### 6.4.7. LOOP Faulty Cases

☞ If the instrument detect the External Power supply adapter connected to instrument will show the message displayed to side.

LOOP		05.06.01	
--- Ω ---A			
FRQ=50.0HZ		VP-PE=230V	
VP-N=231V			
⚠ REMOVE POWER			
P-N			
FUNC	Z2Ω		

**Disconnect the External Power Supply Adapter**

☞ Should the instrument detect that the phase and/or neutral cables are not connected to an installation, screen alongside is displayed when pressing **START**.

LOOP		05.06.01	
--- Ω ---A			
FRQ=50.0HZ		VP-PE= 0V	
VP-N= 1V			
NO VOLTAGE			
P-PE		50V	
FUNC	Z2Ω		UL

**NO VOLTAGE Detected**

☞ Should the instrument detect a voltage between phase and neutral higher of 250V, for example in case the blue cable is connected to an installation phase conductor of a 400V three-phase system, the screen alongside is displayed.

LOOP		05.06.01	
--- Ω ---A			
Freq=50.0HZ		VP-PE=230V	
VP-N=401V			
HIGH VOLTAGE			
P-PE		50V	
FUNC	Z2Ω		UL

**HIGH VOLTAGE Detected**

- ☞ This screen is displayed when the phase conductor has been exchanged with the neutral one. The instrument does not effect the test. Reverse the shuko plug or exchange the black cable with the blue one.

LOOP		05.06.01	
- - - Ω ---A			
FRQ=50.0HZ		VP-N=231V VP-PE= 0V	
CHANGE P-N			
P-PE		50V	
FUNC	Z2Ω		UL

**Phase and Neutral are exchanged.**

- ☞ This screen is displayed when the phase conductor has been exchanged with the Protection Conductors. The instrument does not effect the test. Reverse the phase to earth connection in the plug or exchange the black cable with the green one

LOOP		05.06.01	
- - - Ω ---A			
FRQ=50.0HZ		VP-N= 1V VP-PE= 230V	
CHANGE P-PE			
P-N			
FUNC	Z2Ω		

**Phase and Protection Conductors are exchanged.**

- ☞ This screen is displayed when in a 230V Phase to Phase System the blue conductor was reversed with respect to the green one. The instrument does not effect the test. Reverse the blue and green conductors.

LOOP		05.06.01	
- - - Ω ---A			
FRQ=50.0HZ		VP-N=131V VP-PE= 227V	
CHANGE N-PE			
P-N			
FUNC	Z2Ω		

**Neutral and Protection Conductors are exchanged.**

- ☞ If a contact voltage  $U_t$  **higher than the selected limit ( $U_L$ )** is detected the instrument interrupts the test and emits a **long sound signal** at the end of the test and displays the screen alongside.

LOOP		05.06.01	
--- Ω ---A			
FRQ=50.0HZ		VP-N= 1V Vp-PE= 0V	
U <sub>t</sub> DANGEROUS			
R <sub>A</sub> ↓		50V	
FUNC			UL

Message "U<sub>t</sub>": the instrument doesn't detect an efficient protection circuit.

- ☞ If the instrument detects such a high earth resistance that the earth conductor or the earth installation itself seem to be unreliable, the message alongside is displayed. Check the efficiency of the protective conductor as well as the earth installation.

LOOP		05.06.01	
--- Ω ---A			
FRQ=50.0HZ		VP-N=231V Vp-PE= 40V	
NO PE			
P-PE		50V	
FUNC	Z2Ω		UL

Message "NO PE": the instrument doesn't detect an efficient protection circuit.

- ☞ If the instrument gets overheated, tests cannot be carried out and the message alongside is displayed. Wait until the initial screen is back in order to proceed with measurements.

LOOP		05.06.01	
--- Ω ---A			
FRQ=50.0HZ		VP-N=231V Vp-PE= 40V	
△ HOT △			
P-P			
FUNC	Z2Ω		

Message "hot": the instrument got overheated.

☞ Using the "🔄" mode, if a Phase to Phase voltage is lower than 100V, the instrument displays the screen indicated on side.

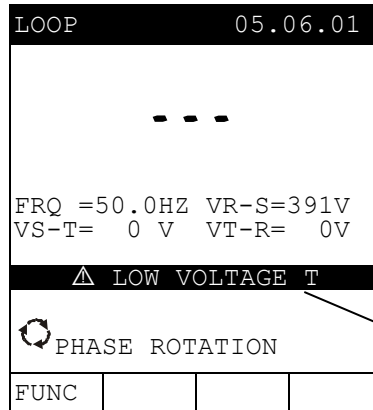

Phase "T2 Voltage is lower than 100V

☞ Using the "🔄" mode, if the instrument detect two phases connected together displays the screen indicated on side.

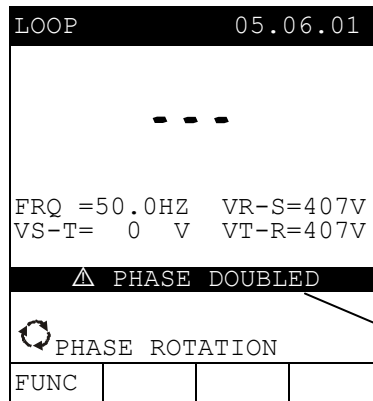

Two phases are connected together.

**THE PREVIOUS RESULTS CANNOT BE SAVED.**

☞ In the mode **P-P**, **P-N** mode the instrument carries out the test and detects a **resistance to higher than 199.9Ω**, the screen alongside is displayed.

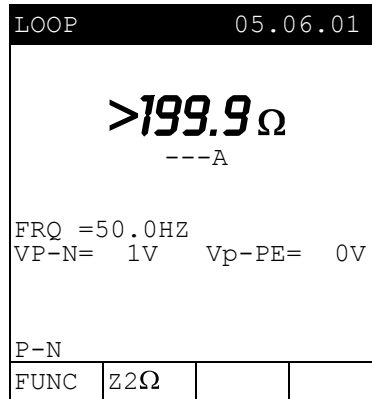

Message ">199.9" means that the Resistance measured is higher than the maximum measurable

**SAVE** This result can be stored pressing the **SAVE** key **twice** (according to paragraph 9.1).

☞ In the mode **P-PE**,  $R_A \perp$  mode the instrument carries out the test and detects a **resistance to higher than 1999Ω**, the screen alongside is displayed.

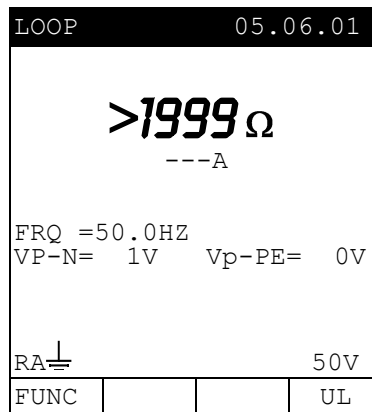

Message ">1999" means that the Resistance measured is higher than the maximum measurable

**SAVE** This result can be stored pressing the **SAVE** key **twice** (according to paragraph 9.1).

☞ In the mode, if the voltage of one or more phase is too low, one or more phase has a low voltage the instrument will show a screen similar to the along side displayed.

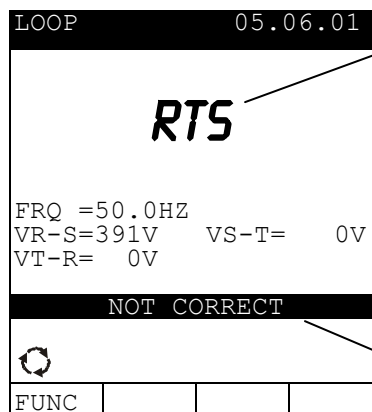

Phase Sequence not correct

Message "LOW Voltage Phase T": means that Phase T has a low voltage value. Similar message for Phase R and S.

**SAVE** This result can be stored pressing the **SAVE** key **twice** (according to paragraph 9.1).



## 6.5. EARTH: SOIL RESISTANCE AND RESISTIVITY MEASUREMENTS

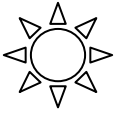

Turn the **switch** on **EARTH** position.

**F1**

The **F1** key permits to select one of the following measuring modes (which can be shown cyclically when pressing the key):

- ☞ Mode "2-W" (the instrument measures the resistance between 2 points).
- ☞ Mode "3-W" (the instrument measures the resistance using two auxiliary earth rods).
- ☞ Mode " $\rho$ " (the instrument measures the ground resistivity).

### WARNING



Never disconnect the test leads from the circuit under test when the message "**MEASURING**" is displayed.

### 6.5.1. Measurement procedure and results of "2-W" and "3-W" mode

- F1**
1. Select "2-W" or "3-W" Earth measurement mode by means of the **F1** key.
  2. Connect the Black, Red, Green and Blue cables to the corresponding input terminals of the instrument **B1**, **B2**, **B3**, **B4** (see possible connections in the following pictures).

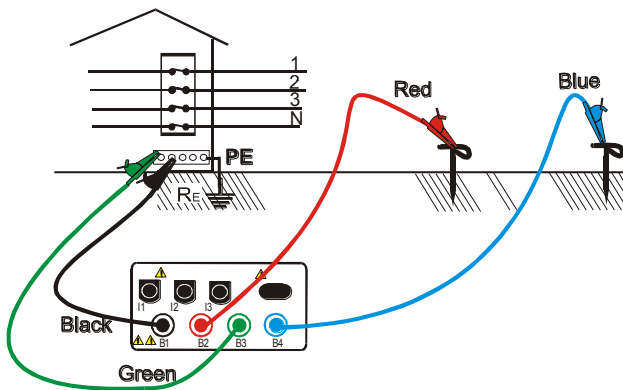

Connection for 3 point Earth resistance measurement

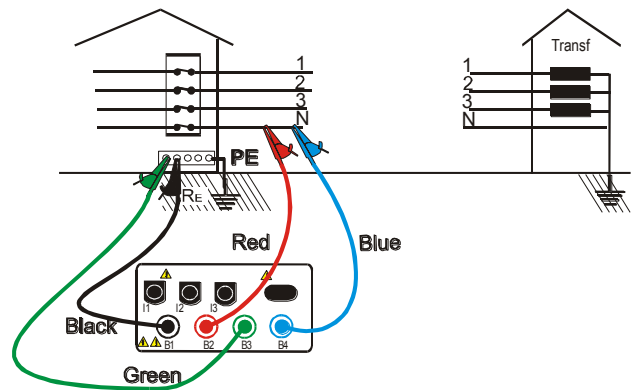

Connection for 2 point Earth Resistance measurement

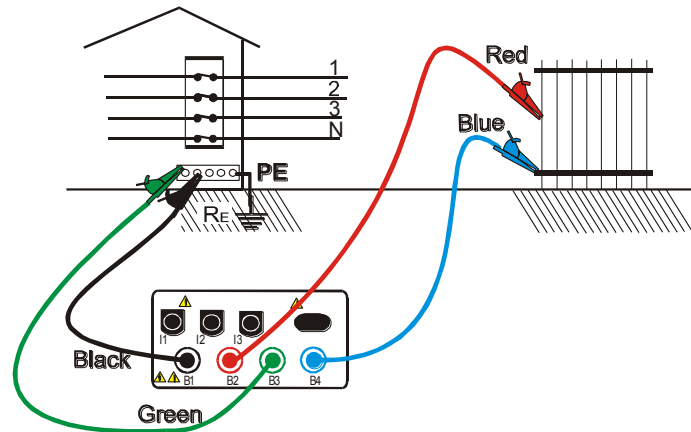

Connection for measuring the resistance between an extraneous conductive part and the earth system



3. Press the **START** key. The instrument starts the test.

At the end of the test the instrument emits a **double sound signal indicating that the test is correctly terminated** and displays the values alongside.

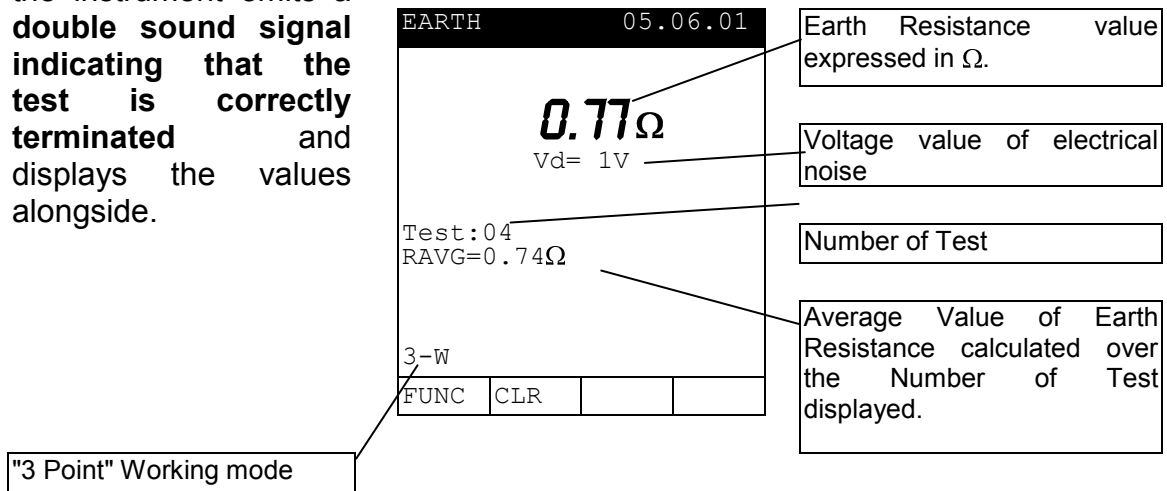

- The instrument will show automatically the Average value of the Earth resistance calculate over the tests performed. Press **F2** to RESET this value and the number of Test.



This result can be stored pressing the **SAVE** key **twice** (according to paragraph 9.1).

### 6.5.2. Measurement procedure and results of "ρ" mode

- F1**
1. Select ρ measurement mode by means of the **F1** key.
  2. Select the distance **d** between the earth rods by means the **F3** and **F4** keys.
  3. Connect the 4 Black, Red, Green and Blue connectors of the single cables in the corresponding input terminals of the instrument **B1**, **B2**, **B3**, **B4**.

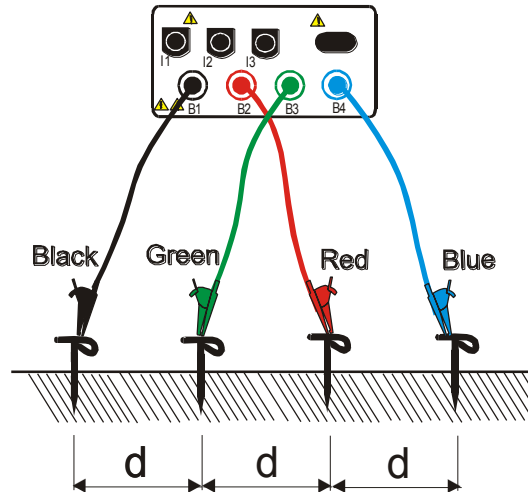

Instrument connection for Earth resistivity measurement

- START STOP**
4. Press the **START** key. The instrument starts the test.

At the end of the test the instrument emits a **double sound signal** indicating that the **test is correctly terminated** and displays the values alongside.

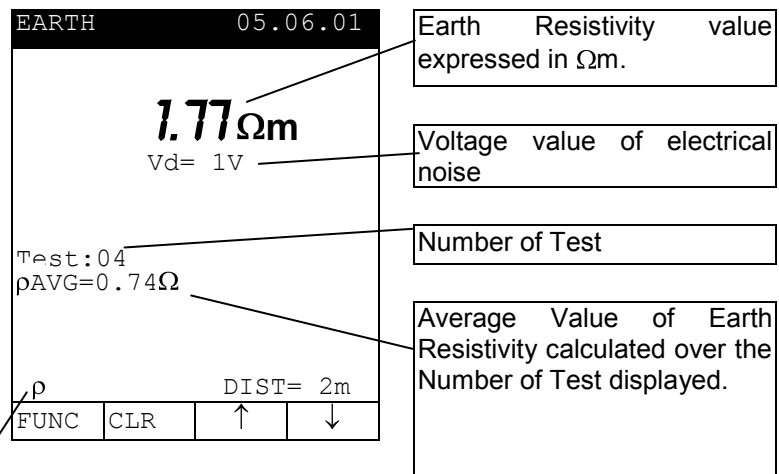

5. The instrument will show automatically the Average value of the Earth Resistivity calculate over the tests performed. Press **F2** to RESET this value and the number of Test.

**SAVE** This result can be stored pressing the **SAVE** key **twice** (according to paragraph 9.1).

### 6.5.3. "2-W", "3-W" and " $\rho$ " faulty cases

☞ If the instrument detect the External Power supply adapter connected to instrument will show the message displayed to side.

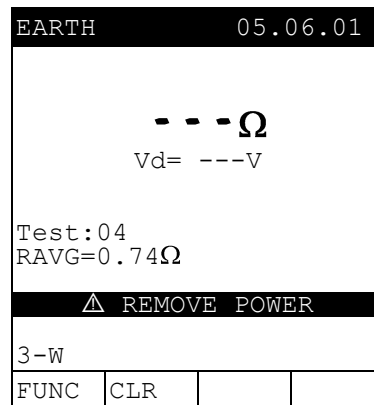

Disconnect the External Power Supply Adapter

☞ If the Instrument detect a voltage values higher than 5V the instrument will shows the screen displayed alongside.

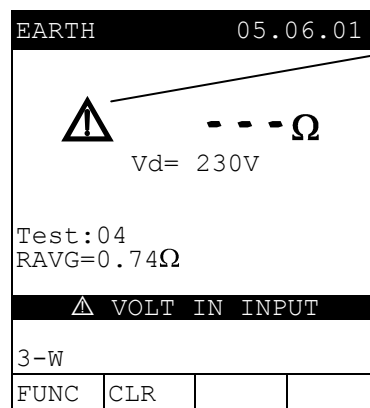

Warning symbol: Voltage noise in input.

☞ The message "**Rc high**" indicates that the instrument can't flow the minimum current necessary for measurement. Check that the terminals are correctly connected and the Auxiliary earth rod connected to B4 (blue conductor) has not been inserted in a pebbly or poor conductive ground. If necessary pour some water around the rod.

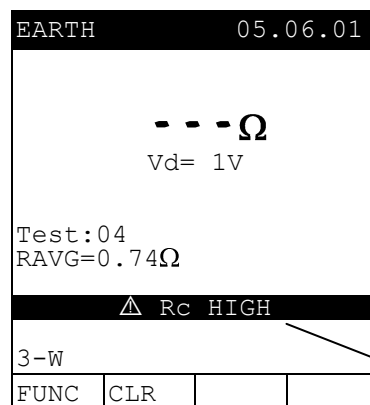

Message "Rc": Check Auxiliary Earth rods.

The message "**Rp high**" indicates that the instrument can't measure correctly the Voltage from Auxiliary Earth rod. Check that the terminals are correctly connected and the Auxiliary earth rod connected to B2 (red conductor) has not been inserted in a pebbly or poor conductive ground. If necessary pour some water around the rod.

EARTH		05.06.01	
- - - Ω Vd= 1V			
Test:04 RAVG=0.74Ω			
△ Rp HIGH			
3-W			
FUNC	CLR		

Message "Rp": Check Auxiliary Earth rods.

The message "**Rp and Rc high**" indicates that the instrument can't measure correctly the Voltage from Auxiliary Earth rod and can't flow the minimum current for measurement. Check that the terminals are correctly connected. Check if the Auxiliary earth rod connected to B2 (red conductor) and B4(blue conductor) has not been inserted in a pebbly or poor conductive ground. If necessary pour some water around the rod.

EARTH		05.06.01	
- - - Ω Vd= 1V			
Test:04 RAVG=0.74Ω			
△ Rp and Rc HIGH			
3-W			
FUNC	CLR		

Message "Rp and Rc HIGH": Check Auxiliary Earth rods.

**THE PREVIOUS RESULTS CANNOT BE SAVED.**

☞ If the Instrument detects a Resistance value higher than  $1999\Omega$ , the instrument will show the screen alongside.

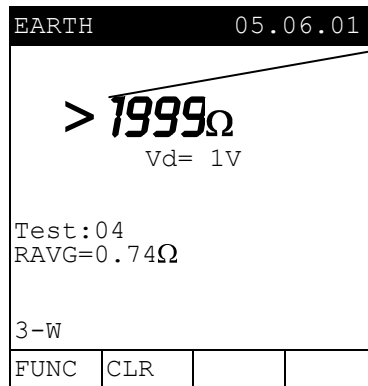

Message ">1999" means that the resistance value is higher than the maximum measurable.



This result can be stored pressing the **SAVE** key **twice** (according to paragraph 9.1).

☞ If the Instrument detects a Resistivity value higher than  $1999k\Omega m$ , the instrument will show the screen alongside.

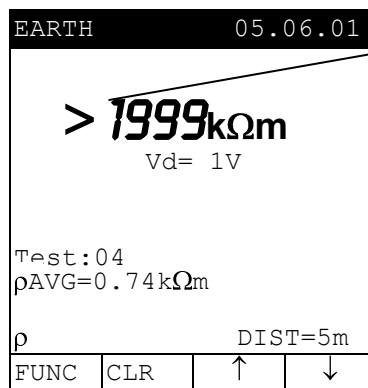

Message ">1999" means that the resistivity value is higher than the maximum measurable.



This result can be stored pressing the **SAVE** key **twice** (according to paragraph 9.1).

**6.6. LOW10A: CONTINUITY TEST WITH 10A TEST CURRENT (GSC57 ONLY)****WARNING**

Before carrying out the continuity test make sure that there is no voltage at the ends of the conductor under test.

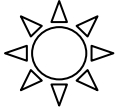

Turn the **switch** on **LOW $\Omega$ 10A** position.

**F1**

This key permits to select one of the following measuring modes (which can be shown cyclically when pressing the key):

- ☞ "**RMEAS**" mode: the instrument measures the Resistance value of the Protection conductor ("Low Voltage Switchgear and control gear assemblies")
- ☞ "**VDROP**" mode: the instrument measures the Voltage Drop and the resistance across the Protection conductor ("Electrical equipment of machines")

**WARNING**

If the resistance is lower than 0.45 $\Omega$  (including the test leads resistance) the continuity test is executed by the instrument with a test current higher than 10A. If the resistance is higher than 0.45 $\Omega$  the continuity test is executed by the instrument with a current lower than 10A.



### 6.6.1. Measurement Procedure and Result of "RMEAS" mode

- F1**
1. Select the "RMEAS" mode by means of the F1 key.
  2. Connect the test leads to B1, B2, B3, B4 input terminals according to the following picture:

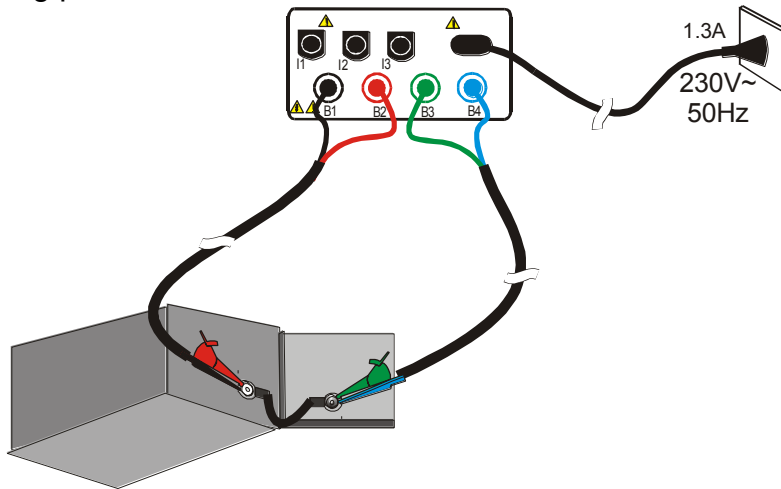

Connection of the test leads during LOW $\Omega$ 10A test.

- F3 F4**
3. Set the resistance limit value by mean the F3 and F4 keys.
  4. Connect the 230V~ 50Hz Power supply socket of the instrument to a power socket using the C5700 cable.
  5. Press the **START** key. The instrument will execute the measurement..



#### WARNING



If the instrument displays "Measuring" it means that it is effecting the measurement. During this phase the instrument test leads are not to be disconnected.

At the end of the test the instrument emits an acoustic signal and display the screen alongside.

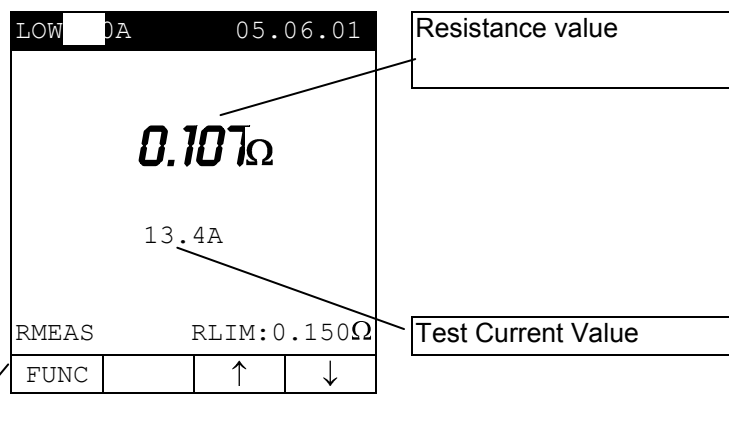

The displayed result can be stored pressing the **SAVE** key **twice** (according to paragraph 9.1).

### 6.6.2. Measurement Procedure and Result of "VDROP" mode

**F1**

1. Select the "VDROP" mode by means of the **F1** key.
2. Connect the test leads to **B1, B2, B3, B4** input terminals according to the following picture:

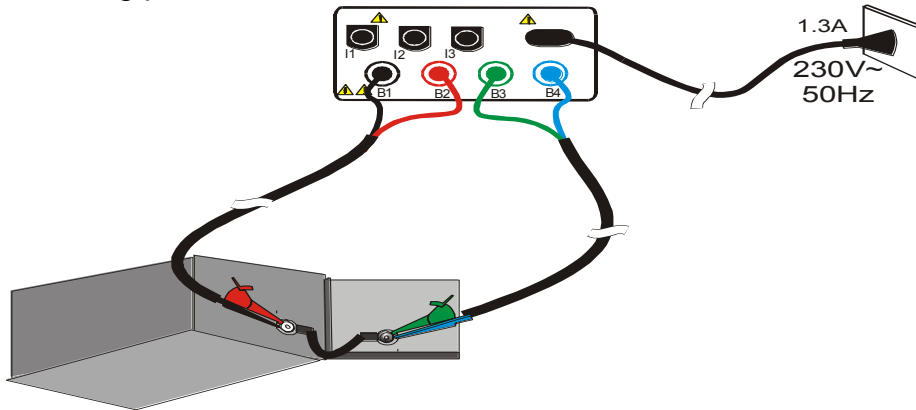

Connection of the test leads during LOWΩ10A test.

**F3 F4**

3. Set the conductor area by mean the **F3** and **F4** keys.
4. Connect the 230V~ 50Hz Power supply socket of the instrument to a power socket using the C5700 cable.
5. Press the **START** key. The instrument will execute the measurement..

**START STOP**

#### WARNING



If the instrument displays "**Measuring**" it means that it is effecting the measurement. During this phase the instrument test leads are not to be disconnected.

At the end of the test the instrument emits an acoustic signal (indicating that the voltage Drop is inside the limits displayed in the following Table) and display the screen alongside.

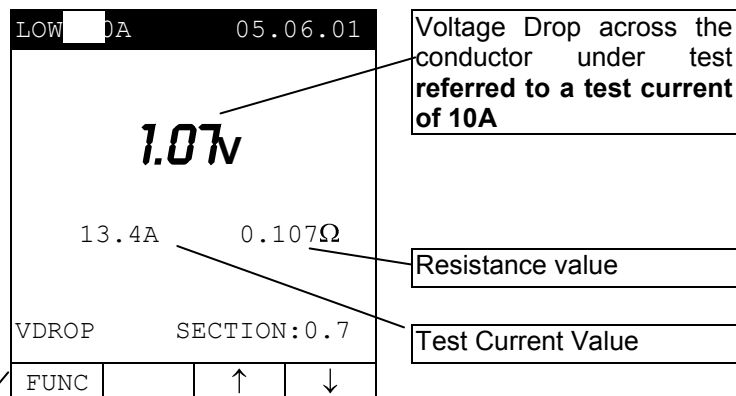

Working mode

**SAVE**

The displayed result can be stored pressing the **SAVE** key **twice** (according to paragraph 9.1).

Area (mm <sup>2</sup> )	Max Voltage Drop (V)	Guidelines
0,5	5	---
0,7	5	
1,0	3,3	---
1,5	2,6	
2,5	1,9	
4,0	1,4	
6,0	1,0	

Table6: table reporting the Voltage Drop limit values.

### 6.6.3. "RMEAS" and "VDROP" faulty cases

☞ if the instrument doesn't notice the presence of Power in the socket "Power ONLY FOR 10A", it visualizes screens represented to side. Check if the C5700 cable is connected to instrument and if the power outlet is fed.

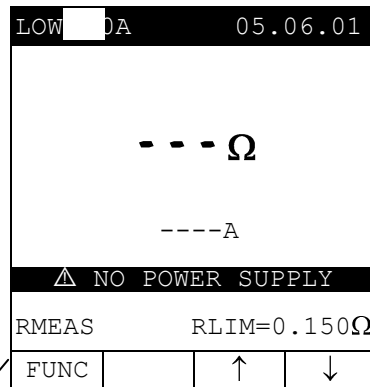

Working mode

☞ If the instrument detects the External Power supply adapter connected to instrument will show the message displayed to side.

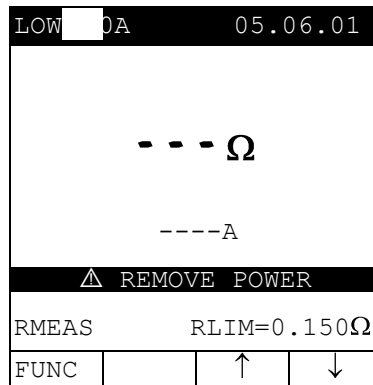

Disconnect the External Power Supply Adapter

### THE PREVIOUS RESULTS CANNOT BE SAVED.

☞ In the RMIS mode If the value of the resistance is higher than the limit, the instrument emits an acoustic signal and displays a screen similar to displayed to side.

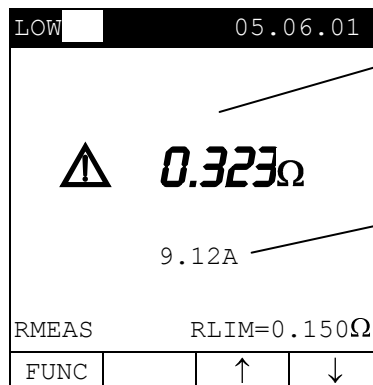

Resistance value higher than limit

Test current



The displayed result can be stored pressing the **SAVE** key **twice** (according to paragraph 9.1).

☞ In the RMIS mode If the value of the resistance is over the maximum measurable, the instrument emits an acoustic signal and displays a screen similar to displayed to side.

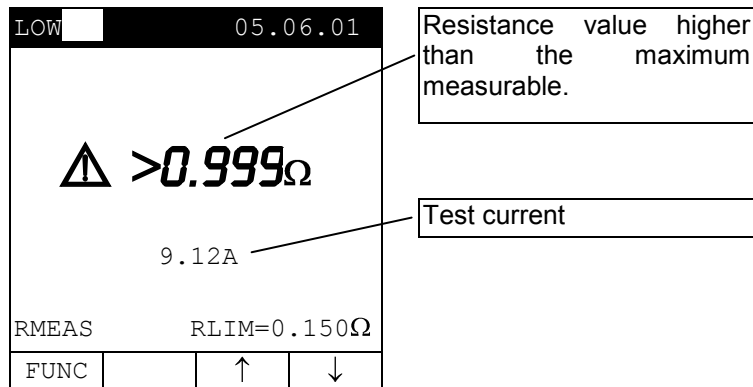

The displayed result can be stored pressing the **SAVE** key **twice** (according to paragraph 9.1).

☞ In the **VDROP** mode If the value of the voltage drop is higher than the limit, the instrument emits an acoustic signal and displays a screen similar to displayed to side.

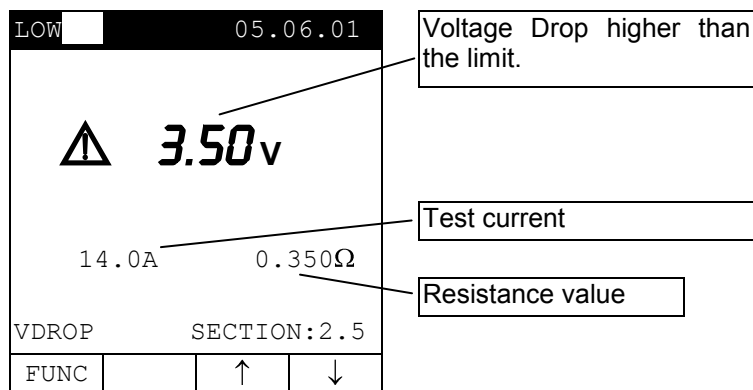

The displayed result can be stored pressing the **SAVE** key **twice** (according to paragraph 9.1).

☞ In the **VDROP** mode If the value of the voltage drop across the conductor under test is over the maximum measurable, the instrument emits an acoustic signal and displays a screen similar to displayed to side.

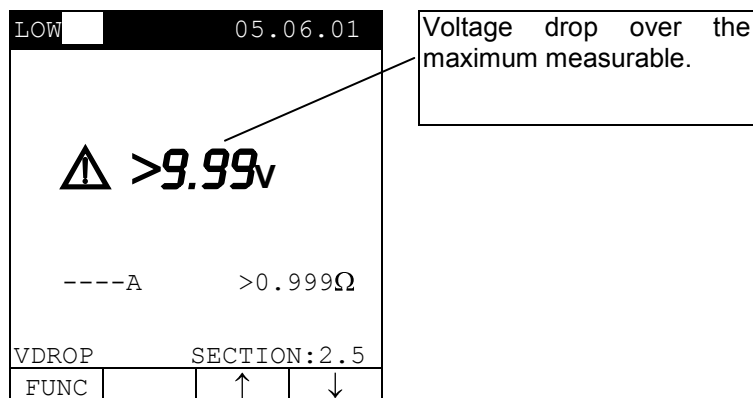

The displayed result can be stored pressing the **SAVE** key **twice** (according to paragraph 9.1).

## 7. AUX: MEASUREMENT WITH EXTERNAL PROBES

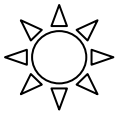

Turn the **switch** on **AUX** position.

The **F4** function key effects the following operations:

**F4**

- ☞ Pressing this key the instrument shows one of the following working mode displayed circularly:
  - ✓ Environmental Parameter & Leakage Current (mA, °C, °F, HR%, m/s, mV, Lux)
  - ✓ Sound Level Measurement

The "**Environmental Parameter & Leakage Current**" mode allows the following operations:

- ✓ **display in real time** the values coming from external probes or clamps.
- ✓ **memorize** the values displayed (pressing SAVE key).
- ✓ **record simultaneously** (pressing the **START** key after a proper setting) up to three Input signal simultaneously among the possibilities illustrated above. **It will be possible to analyse the recorded data ONLY by transferring them to a PC.**
- ✓ **record** (pressing the **START** key) an Input signal coming from an External Probe or clamp, using "**Typical Configurations**" with pre-programmed parameters inside meter (see paragraph 7.2.2). **It will be possible to analyse the recorded data ONLY by transferring them to a PC.**

### WARNING



Please focus the difference between **memorize** and **record**: the former means that the instrument stores in the memory only the actual values displayed while the latter means that you want to store the course of the input signals during a recording time (typically long).

## 7.1. ENVIRONMENTAL PARAMETER AND LEAKAGE CURRENT: REAL TIME MEASUREMENT

This working mode allows to execute real time measurement and recording of Environmental Parameter and Leakage current

**F4** 1. Press this key to access to "AUX" mode.

**F1** 2. Pressing these function keys you will change the measuring unit of the 1st, 2nd, 3rd instrument's input respectively. The following possibilities will be displayed circularly:

<b>F2</b>	---	(Instrument's input disabled)
<b>F3</b>	mA	(Leakage current)
	°C	(Celsius Temperature)
	°F	(Fahrenheit Temperature)
	HR%	(Relative humidity)
	m/s	(Air Speed)
	mV	(Voltage)
	LUX (20)	(Illuminance: Full Scale 20Lux)
	LUX (2k)	(Illuminance: Full Scale 2kLux)
	LUX (20k)	(Illuminance: Full Scale 20kLux)

3. Connect the External probes or clamps to the corresponding instrument inputs.
4. Check if the selector on the probes or clamps is adjusted according to the range set in the instrument. Both range must be set to the same value.

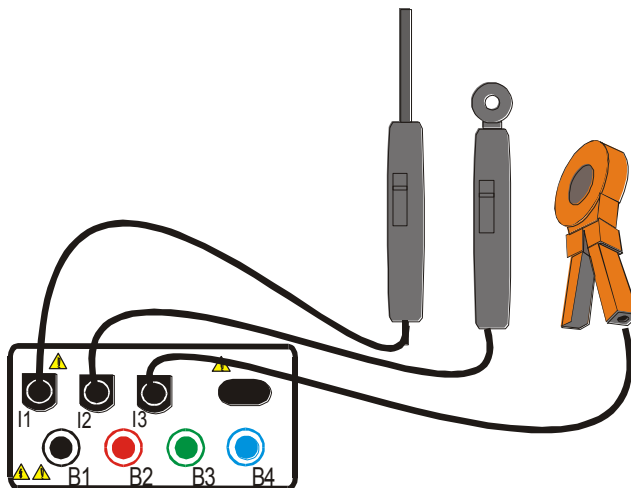

Example of External probes connections

### WARNING



The OFF position of few probes send to probe's output the Battery voltage (approx 9V which is over the expect full scale). This could influence the measurement of the other instrument's inputs. So NEVER left connect to instrument probes with the Selector placed in OFF position.

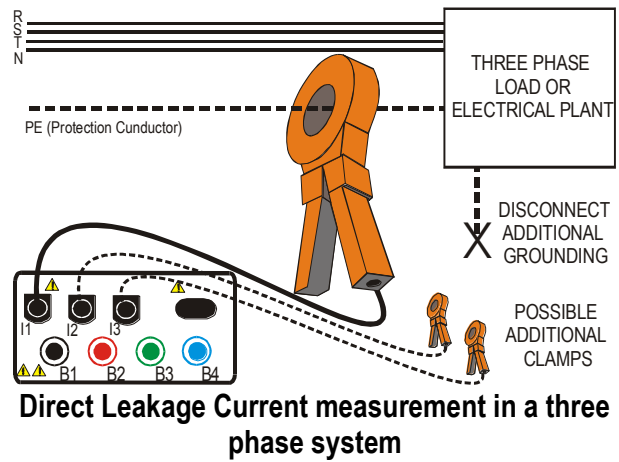
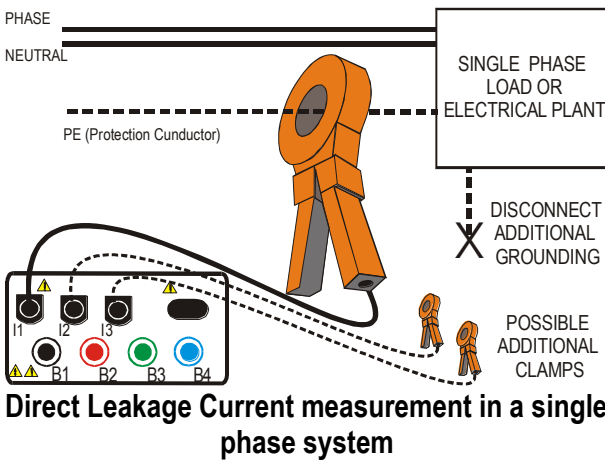
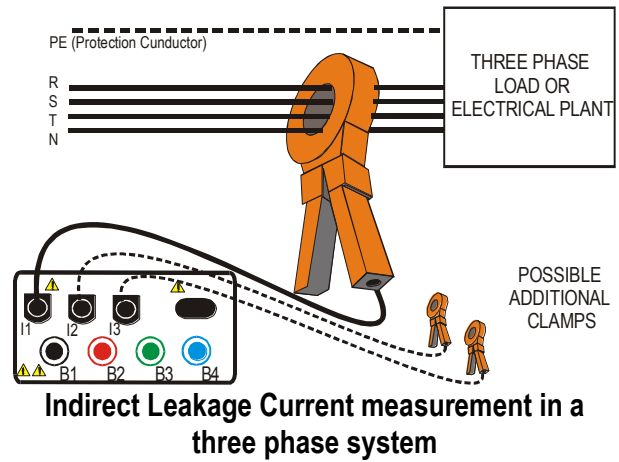
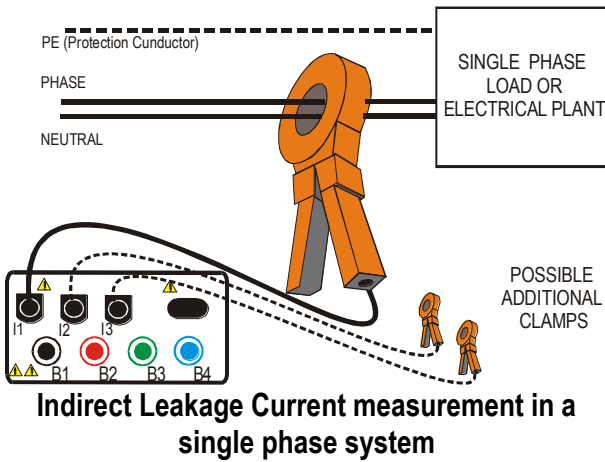

5. The Instrument shows in real time the values present in inputs.

☞ Example of screen.

05.06.01		11:43:04	
AUX			
In1=	23 °C	Example of Input Signal 1	
In2=	23mA	Example of Input Signal 2	
In3=	- - -	Example of Input Signal 3 (disabled)	
In1	In2	In3	PG+



6. Press this key to enable/disable the HOLD function (updating interruption of the displayed data). When the HOLD function is enabled, the word **HOLD** is displayed. This key is disabled during a recording. It's not possible to run a recording if this function is enabled.



7. The displayed result can be stored pressing the **SAVE** key **twice** (according to paragraph 9.1).

## 7.2. ENVIRONMENTAL PARAMETER AND LEAKAGE CURRENT: RECORDING

Before starting a recording we recommend You to check that **real time values** are correct. To this purpose follow the measurement procedure described in paragraph 7.1.

in addition it's fundamental that Instrument settings correspond to the accessories is use. For this we recommend you to check instrument's setting before execute an AUX recording.

To this purpose please check the RECORDER CONFIG settings.

- ☞ **MENU:** to enter in the **MENU** mode and change the instrument settings. It's not possible to enter the configuration MENU during a recording or an energy measurement.
- ☞ **START/STOP:** to record the **selected parameters** according to the instrument's settings (see chapter 10).

### 7.2.1. AUX Basic setting: RECORDER CONFIG

Place the rotary switch in the **AUX** position, press the **MENU** key, using the **F1/F2** keys select the **RECORDER CONFIG** item and press the **ENTER** Key.



#### WARNING

It's not possible to enter the **MENU** during a recording or a Real Time Energy measurement.

MENU GENERAL			
SAFETY TEST MEMORY			
ANALYSER MEMORY			
RESET			
ANALYSER CONFIG			
<b>RECORDER CONFIG</b>			
CONTRAST			
DATE & TIME			
LANGUAGE			
↓	↑		

This option allows you to check and eventually modify the recording parameters and the selected parameters (up to a maximum of 3). The RECORDER CONFIG mode is divided into 2 separate sub-pages:

- ✓ 1<sup>st</sup> page: This page allows you to set the START/ STOP mode (AUTO or MANUAL), the START and STOP time (if AUTO mode is selected) and the Integration Period value. Press **ENTER** to confirm the settings and pass to the following page.  
Press **ESC** to leave the Menu without modifying the existing parameters.
- ✓ 2<sup>nd</sup> page: This page allows the selection of the Input channels to be recorded. Press **ENTER** to confirm the settings and leave the RECORDER CONFIG Menu. Press **ESC** to leave this page without modifying the existing parameters.

The various pages of the "**RECORDER CONFIG**" can be schematised as follows:



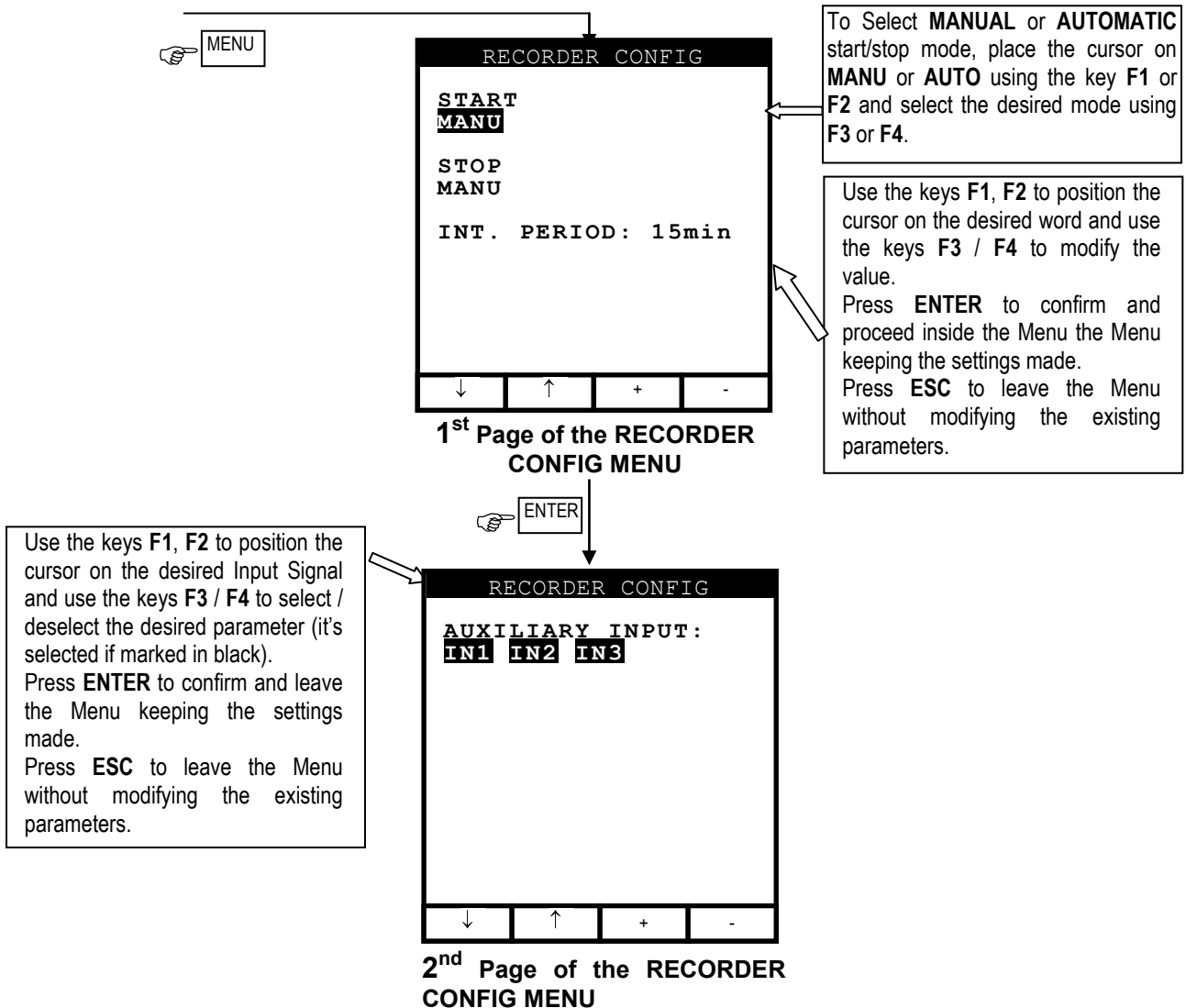

**NOTE:** The Selected Instrument's Input must comply with the "enabled" input in the real time measurement (see par 7.1). So for example if the In3 (Input 3) is disabled in real time measurement , it can't be selected for recording. In case of mistake the instrument will not allow to start a recording showing the message "**Selection error**".

Symbols	Description	Advised settings
START:MAN	The recording of all the selected parameters will start at 00 seconds after pressing <b>START/STOP</b> (see chapter 7).	☺
STOP:MAN	The recording of all the selected parameters will be interrupted manually by pressing <b>START/STOP</b> (see chapter 9).	☺
START:AUTO STOP:AUTO	The recording of all the selected values will be started / interrupted at the set dates and times. In order to start the recording the user will have to press <b>START/STOP</b> to set the instrument in Stand-by mode until the start date and time previously set (see chapter 7).	
INT. PERIOD	The value of this parameter determines every how many seconds the values of <b>all the selected parameters</b> will be memorised (see chapter 16.4.1). Available choices: 5sec,10sec,30sec,1min, 2min 5min, 10min, 15min, 30min, 60min.	15min ☺
IN1, IN2, IN3	Value of the Instrument's input In1, In2, In3 respectively.	☺ IN1, IN2, IN3

For eventual messages displayed see Appendix 1 – MESSAGES DISPLAYED

## 7.2.2. RECORDING: setting of Typical Configurations

The following “**Typical Configurations**” are selectable inside meter:

Standard Configuration	Description
LEAKAGE (I1)	Setting of measuring and recording mode of <b>Leakage current</b> on I1 channel.
TEMP. °C(I1)	Setting of measuring and recording mode of <b>Temperature (°C)</b> on I1 channel.
HUM %HR(I1)	Setting of measuring and recording mode of <b>Relativity Humidity %HR</b> on I1 channel.

To activate the above configurations, follow this procedure:

1. Turn the rotary switch on “**AUX**”.
2. Press **MENU** key. The instrument shows the following screen:

MENU GENERAL			
SAFETY TEST MEMORY			
ANALYSER MEMORY			
RESET			
ANALYSER CONFIG			
RECORDER CONFIG			
CONTRAST			
DATE&TIME			
LANGUAGE			
↓	↑		

3. Press **MENU** key again. The instrument displays a screen as shown below (picture on the left). In this way is possible select the desired configuration on I1 channel with **F1** or **F2** key.

TYPICAL CONFIG.			
LEAKAGE (I1)			
TEMP. °C (I1)			
HUM %HR (I1)			
↓	↑		

Configuration selection

TYPICAL CONFIG.			
LEAKAGE (I1)			
TEMP. °C (I1)			
HUM %HR (I1)			
Data saved			
↓	↑		

Confirmation configuration selection

4. Press **ENTER** key. The instrument displays the message “**Data saved**” for a while to confirm the desired configuration (see above picture on the right). The instrument return on the measure mode and you can start recording by pressing **START/STOP** key.

## 8. ANALYSER

This function allows the following operations:

- ✓ **display in real time** the electrical parameters of a single phase and three-phase systems (with and without neutral wire) and the harmonic analysis of voltages and currents.
- ✓ **conduct a direct Energy measurement** (without memorizing).
- ✓ **memorize** (pressing **SAVE** key) the sampled values of the Parameters present at instrument input generating a "Smp" record inside instrument memory. **It will be possible to analyse the memorized data ONLY by transferring it to a PC.**
- ✓ **record simultaneously** (pressing the **START** key after a proper setting): RMS values of voltages, currents, corresponding harmonics, active, reactive and apparent powers, power factors and  $\cos\phi$ , active, reactive and apparent energies, voltage anomalies (voltage sag and surge) with 10ms resolution. **It will be possible to analyse the recorded data ONLY by transferring them to a PC.**
- ✓ **record simultaneously** (pressing the **START** key) values of Voltage and Current values coming from test leads and Clamps, using "**Typical Configurations**" with pre-programmed parameters inside meter (see paragraph 10.2). **It will be possible to analyse the recorded data ONLY by transferring them to a PC.**

It's fundamental the Instrument settings correspond to the Installation type under test and accessories is use. For this we recommend you to check instrument's setting before execute an ANALYSIS measurement.

Select the **ANALYSER** rotary switch position. By pressing the **MENU** key the following screen will be displayed:

MENU GENERAL			
<b>SAFETY TEST MEMORY</b>			
ANALYSER MEMORY			
RESET			
ANALYSER CONFIG			
RECORDER CONFIG			
CONTRAST			
DATE & TIME			
LANGUAGE			
↓	↑		

It's not possible to enter the **MENU** during a recording or a Real Time Energy measurement.

**Generally to check instrument's settings you must check "ANALYSER CONFIG" and "RECORDER CONFIG" items.**

## 8.1. BASIC SETTING: ANALYSER CONFIG

Place the rotary switch in the **ANALYSER** position, press the **MENU** key, using the **F1/F2** keys select the **ANALYSER CONFIG** item and press the **ENTER** Key.

The following page will be displayed:

ANALYSER CONFIG			
SYSTEM	:	<b>3PH4W</b>	
FREQUENCY	:	50HZ	
CURRENT RANGE	:	1000A	
CLAMP TYPE	:	FlexINT	
TV RATIO	:	0001	
PASSWORD	:	ON	
↓	↑	+	-

This page of setting can be confirmed by pressing the **ENTER** key or cancelled by pressing the **ESC** key.

### 8.1.1. How to set the type of electrical system under test

This parameter permits you to select the type of electrical system under test among the following configurations:

- ✓ **SINGLE:** single phase system
- ✓ **3PH3W:** 3 wires system (three-phase system without neutral)
- ✓ **3PH4W:** 4 wires system (three-phase system with neutral)

The connections to the instrument inputs will have to be in keeping with the type of system selected.

Position the cursor on the corresponding word by pressing the keys **F1** and **F2** and set the desired value by pressing the keys **F3** and **F4**.

### 8.1.2. How to set the fundamental frequency

Position the cursor on the corresponding word by pressing the keys **F1** and **F2** and select the network frequency between the possible values **50Hz** and **60Hz** by pressing the keys **F3** and **F4**. This parameter is important **ONLY** if the input voltage is not sufficient to recognise the value of the frequency (for example, only the clamps for the current measurement are connected). In this case the instrument generates an internal synchronism equal to the value of the set frequency.

### 8.1.3. How to set the current range

The value of this parameter **must be always equal to the full scale of the current clamps** used to take the measurement. In case multi-scale clamps are used, the value of this parameter must be equal to the scale selected on the clamps.

Set the desired value by pressing the keys **F3** and **F4**.

#### 8.1.4. How to set the Clamp Type

The value of this parameter **must be always equal to the clamp type you are using.**

Two types of clamps are available:

- ✓ STD: for Standard clamps or Current Transformer.
- ✓ FlexEXT: for Flexible clamps with External electronic control box
- ✓ FlexINT: for Flexible clamps without any electronic control box (GSC53N and ZG47).

Set the desired value by pressing the keys **F3** and **F4**.



#### WARNING

If "FlexINT" is selected (**GSC53N and ZG47**), the current range could be set only to 1000A or 3000A.

#### 8.1.5. How to set the value of the transformer voltage ratio (TV RATIO)

The instrument can also be interfaced with step-down transformers in the equipment under test: it can display the value of the voltages present on the primary winding of these transformers. To do this it will be necessary to set the value of the transformers' windings ratio from 2:1 to 3000:1. The default is set at 1:1 for measurements of none transformer systems.

Select "TV RATIO" in the ANALYSER CONFIG menu. Set the desired value by pressing the keys **F3** and **F4**.

#### 8.1.6. How to enable/disable the password

The instrument is provided with a protective routine to avoid the risk of being disturbed or interrupted during a recording or an energy measurement. Once a recording or a direct energy measurement has been started (with the option "PASSWORD" enabled), after about 3 minutes from the last key pressure or switch rotation it won't be possible to press START/STOP to stop the recording, "PASSWORD" will be displayed and it will be necessary to insert the password.

In order to insert the password (which is not changeable), press the multifunction keys in the following sequence (within 10 seconds):

**F1, F4, F3, F2**

If you wait more than about 10 seconds the display will return to the meter mode and the instrument will continue recording. If you insert a wrong password the message "Password error" will be displayed under "PASSWORD". After a few seconds the display will return to meter mode and the instrument will continue recording. In order to enable/disable this option the correct password will have to be entered. The display will return to meter mode and START/STOP will have to be pressed again to stop the recording. You will then need to re-enter the "ANALYSER CONFIG" menu and scroll up or down to the item "PASSWORD: ON" using the keys **F1** and **F2**. Then turn the password off by pressing the keys **F3** and **F4**.

## 8.2. BASIC SETTING: RECORDER CONFIG

Place the rotary switch in the **ANALYSER** position, press the **MENU** key, using the **F1/F2** keys select the **RECORDER CONFIG** item and press the **ENTER** Key.

This option allows you to check and eventually modify the recording parameters and the selected parameters (up to a maximum of 62+Frequency). If the number of selected values exceeds 63 the message "**too many param**" will be displayed. The RECORDER CONFIG mode is divided into 4 separate sub-pages:

- ✓ 1<sup>st</sup> page: This page allows you to set the START/ STOP mode (AUTO or MANUAL), the START and STOP time if AUTO mode is selected, the Integration Period value, the Enabling/Disabling of Voltage Anomalies detection, the Enabling/Disabling of Harmonics detection. Press **ENTER** to confirm the settings and pass to the following page.  
Press **ESC** to leave the Menu without modifying the existing parameters.
- ✓ 2<sup>nd</sup> page: This page is devoted to the settings relevant to the **VOLTAGE** recording. Press **ENTER** to confirm the settings and pass to the following page.  
Press **ESC** to leave this page without modifying the existing parameters.  
From this page you can enter the sub-page "Harmonics" which permits to select the voltage harmonics to be recorded.  
Press **ENTER** to confirm the settings and leave the "Menu Harmonics".  
Press **ESC** to leave the "Menu Harmonics" without modifying the existing parameters.
- ✓ 3<sup>rd</sup> page: This page is devoted to the settings relevant to the **CURRENT** recording. Press **ENTER** to confirm the settings and pass to the following page.  
Press **ESC** to leave this page without modifying the existing parameters.  
From this page you can enter the sub-page "Harmonics" which permits to select the current harmonics to be recorded.  
Press **ENTER** to confirm the settings and leave the "Menu Harmonics".  
Press **ESC** to leave the "Menu Harmonics" without modifying the existing parameters.
- ✓ 4<sup>th</sup> page: Menu composed of two sub-pages devoted to the selection of the **POWERS and ENERGIES** to be recorded. From this page you can enter the sub-page "POWER" and "ENERGY" which permits to select the parameters to be recorded.  
Selecting the active powers for the recording, the corresponding active energies will be automatically selected.  
Selecting the reactive powers for the recording, the corresponding reactive energies will be selected.  
Press **ENTER** to leave this page confirming the modifications made.  
Press **ESC** to leave the "Menu" without modifying the existing parameters.

The various pages of the "**RECORDER CONFIG**" can be schematised as follows:

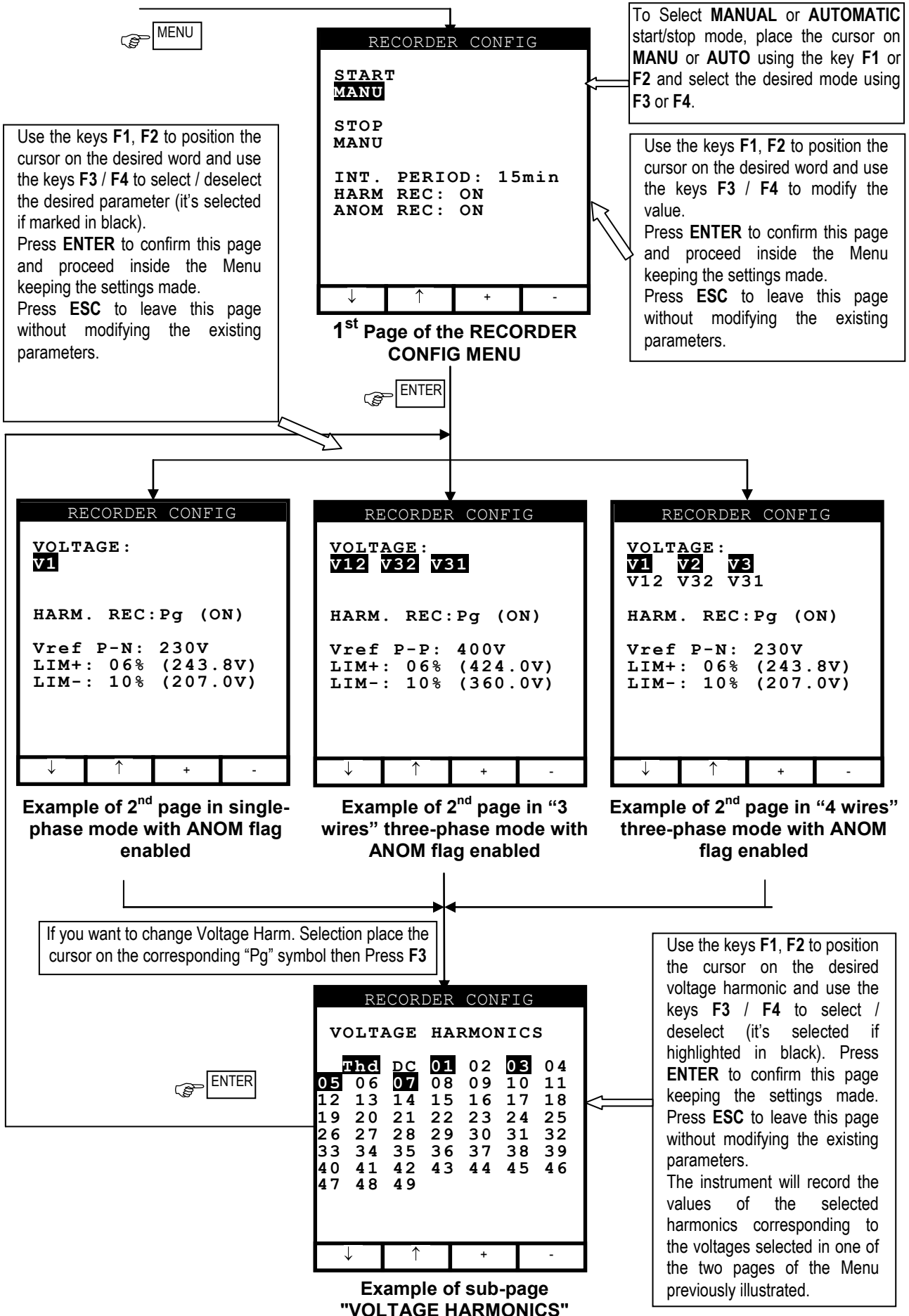

Use the keys **F1**, **F2** to position the cursor on the desired word and use the keys **F3** / **F4** to modify the value or select / deselect the desired parameter (it's selected if marked in black). Press **ENTER** to confirm this page and proceed inside the Menu keeping the settings made. Press **ESC** to leave this page without modifying the existing parameters.

From 2<sup>nd</sup> page of RECORDER CONFIG MENU

ENTER

RECORDER CONFIG

CURRENT:  
**I1**

HARM. REC:Pg (ON)

↓ ↑ + -

Example of 3<sup>rd</sup> page in single-phase mode

RECORDER CONFIG

CURRENT:  
**I1 I2 I3**

HARM. REC:Pg (ON)

↓ ↑ + -

Example of 3<sup>rd</sup> page in "3 wires" three-phase mode

RECORDER CONFIG

CURRENT:  
**I1 I2 I3 IN**

HARM. REC:Pg (ON)

↓ ↑ + -

Example of 3<sup>rd</sup> page in "4 wires" three-phase mode

If you want to change Current Harm. Selection place Cursor on the corresponding "Pg" symbol then Press **F3**

ENTER

RECORDER CONFIG

CURRENT HARMONICS

	Thd	DC	<b>01</b>	02	<b>03</b>	04
<b>05</b>	06	<b>07</b>	08	09	10	11
12	13	14	15	16	17	18
19	20	21	22	23	24	25
26	27	28	29	30	31	32
33	34	35	36	37	38	39
40	41	42	43	44	45	46
47	48	49				

↓ ↑ + -

Example of sub-page "CURRENT HARMONICS"

Use the keys **F1**, **F2** to position the cursor on the desired current harmonic and use the keys **F3** / **F4** to select / deselect (it's selected if marked in black). Press **ENTER** to confirm this page. Press **ESC** to leave this page without modifying the existing settings. The instrument will record the values of the selected harmonics corresponding to the currents selected in one of the two pages of the Menu previously illustrated.



From 3<sup>rd</sup> page  
of RECORDER CONFIG MENU

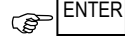

```

RECORDER CONFIG
CO-GENERATION : ON
POWER : Pg
ENERGY : Pg
    
```

Example of 4<sup>th</sup> page

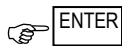

In order to select the POWER to be recorded use the multifunction keys F1, F2 to position the cursor on the corresponding "Pg" Symbol and then press F3

```

RECORDER CONFIG
P1    O1i    O1c    S1
Pf1   dPf1
    
```

Example of POWER sub-page in single-phase mode

```

RECORDER CONFIG
Pt    P12    P32
Oti   O12i   O32i
Otc   O12c   O32c
St    S12    S32
Pft   dPft
    
```

Example of POWER sub-page in "3 wires" three-phase mode

```

RECORDER CONFIG
Pt    P1    P2    P3
Oti   O1i   O2i   O3i
Otc   O1c   O2c   O3c
St    S1    S2    S3
Pfi   Pf1  Pf2  Pf3
dPfi  dPf1 dPf2 dPf3
    
```

Example of POWER sub-page in "4 wires" three-phase mode



### WARNING

- Selecting the active powers for the recording, the corresponding active energies will be automatically selected.
- Selecting the reactive powers for the recording, the corresponding reactive energies will be selected.

From 3<sup>rd</sup> page  
of RECORDER CONFIG MENU

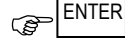

```

RECORDER CONFIG
CO-GENERATION : ON
POWER : Pg
ENERGY : Pg
    
```

Example of 4<sup>th</sup> page

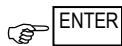

In order to select the ENERGIES to be recorded use the keys F1, F2 to position the cursor on the corresponding "Pg" Symbol and then press F3

```

RECORDER CONFIG
Ea1  Eri1  Ercl  Es1
    
```

Example of ENERGY sub-page in single-phase mode

```

RECORDER CONFIG
Eat  Erit  Erct  Est
    
```

Example of ENERGY sub-page in "3 wires" three-phase mode

```

RECORDER CONFIG
Eat  Ea1  Ea2  Ea3
Erit Eri1 Eri2 Eri3
Erct Ercl Erc2 Earc3
    
```

Example of ENERGY sub-page in "4 wires" three-phase mode



### WARNING

- Selecting/deselecting the active energies for the recording, the corresponding active powers will be automatically selected/deselected.
- Selecting/deselecting the reactive energies for the recording, the corresponding reactive powers will be selected/deselected.
- Selecting/deselecting the reactive energies for the recording, the corresponding reactive powers will be selected/deselected.

Symbols	Description	Advised settings
START:MAN	The recording of all the selected parameters will start at 00 seconds after pressing <b>START/STOP</b> (see chapter REF _Ref6712586 \r \h 10.1).	☺
STOP:MAN	The recording of all the selected parameters will be interrupted manually by pressing <b>START/STOP</b> (see chapter 10.1).	☺
START:AUTO STOP:AUTO	The recording of all the selected values will be started / interrupted at the set dates and times. In order to start the recording the user will have to press START/STOP to set the instrument in Stand-by mode until the start date and time previously set (see chapter REF _Ref6712622 \r \h 10.1).	
INT. PERIOD	The value of this parameter determines every how many seconds the values of <b>all the selected parameters</b> will be memorised (see chapter 17.13.1). Available choices: 5sec,10sec,30sec,1min,2min,5min,10min,15min,30min,60min.	15min ☺
HARM REC.	<p><b>ON</b> = the instrument will record the values of the selected <b>voltage and current harmonics</b> corresponding to the voltages and currents selected in the corresponding pages "Voltage" and "Current".</p> <p>Example: If the following Parameters are selected:</p> <p><b>a) Phase Voltage 1 and 2, THd, Harmonics 1,3,5.</b>  <b>b) Phase Current 2 and 3, THd, Harmonics 3,5,7.</b></p> <p>The instrument will record:</p> <p><b>a) The Phase Voltage 1 and 2, THD and Harmonics 1,3,5 of the Phase Voltage 1 and 2 while it will not record anything about Phase Voltage 3</b>  <b>b) The Phase Current 2 and 3, THD and Harmonics 3,5,7 of the Phase Current 2 and 3 while it will not record nothing about Phase Current 1</b></p> <p><b>OFF</b> = the instrument <b>will not record</b> any voltage or current harmonic selected</p>	☺
ANOM REC.	<p><b>ON</b> = the Instrument will record Voltage Anomalies (voltage Sag and Surge) (see paragraph 17.10)</p> <p><b>OFF</b> = the instrument <b>will not record</b> any voltage Sag and Surge</p>	☺
V1, V2, V3 V12, V23 or V32, V31	RMS value of the voltage of phase 1, phase 2, phase 3 respectively, values of the phase-to-phase voltages 1-2, 2-3 or 3-2 and 3-1.	☺ Single phase: <b>V1</b> 3 wires <b>V<sub>12</sub> V<sub>32</sub> V<sub>31</sub></b> 4 wires <b>V<sub>1</sub>, V<sub>2</sub>, V<sub>3</sub></b>
THD, DC, 01...49	Voltage Total Harmonic Distortion, DC Component, 01..49 Harmonics respectively	☺ <b>THD,01,03,05,07</b>
Vref (only if ANOM. REC flag has been set ON)	RMS reference value for Voltage used in Voltage Anomalies detection (Voltage Sag and Surge). The Reference is: a) Voltage Phase to Neutral for Single Phase and 4 wires three phase system b) Voltage Phase to Phase for 3 wires three phase system	☺ Single phase: <b>230V</b> 3 wires: <b>400V</b> 4 wires <b>230V</b>
LIM+, LIM- (only if ANOM. REC flag has been set ON)	High and Low Voltage Percent threshold used in Voltage Anomalies detection (Voltage Sag and Surge). These parameters can be adjusted in range: 3% ÷ 30% (step 1%). Example: Three Phase System 4 wires, Vref = 230V LIM+= 6%, LIM-=10% => High Lim = 243.8V, Low Lim = 207.0V The Instrument will detect a voltage Anomalies if the RMS Voltage Values (calculated every 10ms) beyond the above calculated thresholds (see paragraph 17.10).	☺ Single phase, 3wires, 4wires: <b>+6% / -10%</b>
I1, I2, I3, IN	RMS value of the current of phase 1, phase 2, phase 3 and of the neutral respectively.	☺ Single phase: <b>I1</b> 3 wires: <b>I1, I2, I3</b> 4 wires <b>I1, I2, I3, IN</b>
THD, DC, 01..49	Current Total Harmonic Distortion, DC Component, 01..49 Harmonics respectively	☺ <b>THD,01,03,05,07</b>

CO-GENERATION	ON = the instrument is able to face situations of CO-GENERATION of electrical equipment (that is, the equipment under test is able to generate energy besides absorbing it). Accordingly, the instrument will record the powers and energies both absorbed and generated (see paragraph 17.12.1). <b>If this flag is enabled the maximum number of parameters which can be selected decrease to 38.</b>	
	OFF = the instrument will record ONLY the powers and energies absorbed.	☺
Pt, P1, P2, P3, P12, P32	Values of the active power (total, of phase 1, phase 2 and phase 3) (only for 3 wires measurement) value of the power measured by the Wattmeter 1-2 and 3-2 respectively	☺ Single phase: P1 3 wires: Pt 4 wires Pt, P1, P2, P3
Qti, Q1i, Q2i, Q3i, Q12i, Q32i	Values of the inductive reactive power (total, of phase 1, phase 2, phase 3) (only for 3 wires measurement) value of the reactive inductive power measured by the VAR meters 1-2 and 3-2 respectively	☺ Single phase: Q1i Q1c 3 wires: Qti Qtc 4 wires Qti Q1i Q2i, Q3i
Qtc, Q1c, Q2c, Q3c, Q12c, Q32c	Values of the capacitive reactive power (total, of phase 1, phase 2, phase 3) (only for 3 wires measurement) value of the reactive capacitive power measured by the VA meters 1-2 and 3-2 respectively	☺ Qtc Q1c Q2c, Q3c
St, S1, S2, S3, S12, S32	Values of the apparent power (total, of phase 1, phase 2, phase 3) (only for 3 wires measurement) value of the power measured by the VA meters 1-2 and 3-2 respectively	☺ Single phase: S1 3 wires: St 4 wires St, S1, S2, S3
Pft, Pf1, Pf2, Pf3	Values of the power factors (total, of phase 1, phase 2 and phase 3 respectively)	☺
dpft, dpf1, dpf2, dpf3	Values of the $\cos\varphi$ (total, of phase 1, phase 2 and phase 3 respectively)	☺ Single phase: Pf1 dPf1 3 wires: Pft dPft 4 wires Pft Pf1 Pf2 Pf3 dPft dPf1 dPf2 dPf3
Eat, Ea1, Ea2, Ea3	Values of the active energy (total, of phase 1, phase 2, phase 3)	☺ Single phase: Ea1 3 wires: Eat 4 wires Eat Ea1 Ea2 Ea3
Erit, Eri1, Eri2, Eri3	Values of the inductive reactive energy (total, of phase 1, phase 2 and phase 3)	☺
Erct, Erc1, Erc2, Erc3	Values of the capacitive reactive energy (total, of phase 1, phase 2, phase 3)	☺ Single phase: Eri1 Erc1 3 wires: Erit Erct 4 wires Erit Eri1 Eri2 Eri3 Erct Erc1 Erc2 Erc3

The value of the network frequency is automatically selected if at least one phase voltage (for the single-phase mode or the 4 wires three phase mode) or at least one phase-to-phase voltage (for the 3 wires three phase mode) is selected.

The symbols "i" and "c" stand for reactive powers (Q), power factors (Pf) and  $\cos\varphi$  (dpf) inductive and capacitive respectively.

Selecting a power factor (Pf) or a  $\cos\varphi$  (dPf) for the recording automatically their inductive value and their capacitive value will be recorded separately.

For eventual messages displayed see Appendix 1 – MESSAGES DISPLAYED

### 8.3. ANALYSER FUNCTIONS

**F3** ☞ For a simple usage, the main working mode of the ANALYSER mode can be selected by means of **F3** and **F4**.

**F4**

- ☞ "**VOLTAGE**" function: to be used to display **voltage and corresponding harmonics** (see paragraph 8.4)
- ☞ "**CURRENT**" function: to be used to display **current and corresponding harmonics** (see paragraph 8.5)
- ☞ "**POWER**" function: it permits to display **all the parameters measurable by the instrument**: voltage, current, active, reactive and apparent power, power factor,  $\cos\varphi$  and energy (see paragraph 8.6)
- ☞ "**ENERGY**" function: to be used to display **active, reactive and apparent power, power factor,  $\cos\varphi$  and energy** (see paragraph 8.7)

More practically, we may schematise the right procedure of use the **ANALYSER** function as follows:

1. Check and eventually modify the "ANALYSER CONFIG" settings of the instrument
2. Using **F3** and **F4**, select the type of measurement to be taken
3. Connect the instrument to the electrical system to be tested
4. Evaluate the values of the parameters under test
5. If you want to record:
  - a) Decide what to record
  - b) Press **MENU** and check if the "RECORDER CONFIG" settings meet your requirements.
  - c) Consider Typical Configuration recording (see paragraph 10.2).
6. Connect the External Power Supply A0050 (optional for GSC57).
7. Start the recording by pressing **START/STOP** key.

## 8.4. "VOLTAGE" FUNCTION

This function permits you to display in real time the RMS value of AC/DC voltage, the peak and Thd value of the 3 phase voltages (see paragraph REF\_Ref530398168 \r \h 17.11), the waveform and the harmonic spectrum of the 3 phase voltages.

### 8.4.1. Symbols

The VOLTAGE position has three working modes:

- ✓ METER
- ✓ WAVE
- ✓ HARM

These modes will be described in detail in the next paragraphs.  
The symbols used are described below:

Symbol	Description
V1, V2, V3	RMS value of the voltage of phase 1, phase 2, phase 3 respectively
V12, V23 or V32, V31	RMS Value of the phase to phase voltages
Vpk1, Vpk2, Vpk3, Vpk12, Vpk32	Peak value of the voltage of phase 1, phase 2, phase 3 and of the phase to phase voltage 12 and 32 respectively
h01 ÷ h49	Harmonic 01 ÷ Harmonic 49.
ThdV	Factor of total harmonic distortion of the voltage (see paragraph 17.11).
freq	Network frequency
Phseq	Phase sequence indicator "123"→ correct "132"→ inverted "023"→ null voltage on the black wire "103"→ null voltage on the red wire "120"→ null voltage on the green wire "100"→ null voltages on the red and green wires "020"→ null voltages on the black and green wires "003"→ null voltages on the black and red wires

Table 7: symbols used in the position **VOLTAGE**

### 8.4.2. "METER" mode

In this mode the instrument shows one of the below screens according to the settings made as per paragraph 8.1.

27.09.00		17:35:12	
VOLTAGE SINGLE PHASE			
V1	=	230.2	V
Vpk1	=	325.5	V
ThdV	=	0.0	%
freq	=	50.0	Hz
HARM.	WAVE	PG-	PG+

Example of screen in single-phase mode

27.09.00		17:35:12	
VOLTAGE			
V12	=	384.2	V
V32	=	385.4	V
V31	=	383.7	V
freq	=	50.0	Hz
HARM.	WAVE	PG-	PG+

Example of screen in "3 wires" three-phase mode

27.09.00		17:35:12	
VOLTAGE			
V1	=	230.2	V
V2	=	230.5	V
V3	=	230.6	V
V12	=	384.2	V
V23	=	385.4	V
V31	=	383.7	V
freq	=	50.0	Hz
Phseq	=	123	
HARM.	WAVE	PG-	PG+

Example of screen in "4 wires" three-phase mode

The symbols used are described in Table 7

For any message displayed see Appendix 1 – MESSAGES DISPLAYED.

Following keys are enabled:

- ☞ **F1:** to pass to "HARMONIC" mode (see paragraph 8.4.3).
- ☞ **F2:** to pass to "WAVE" mode (see paragraph 8.4.4).
- ☞ **F3/F4:** to pass to previous/next function respectively.
- ☞ **SAVE:** to save in the instrument memory a record of "Smp" type (see paragraph 9.2) containing the instantaneous values of voltage and current present on the instrument inputs. This function is disabled during a recording.
- ☞ **ENTER/HOLD:** to enable/disable the HOLD function (updating interruption) of the displayed data. All the previous functions remain however available. When the HOLD function is enabled, the word **HOLD** is displayed. When this function is enabled it's not possible to record or take an energy measurement. This function is disabled during a recording or an energy measurement.
- ☞ **MENU:** to enter in the **MENU** mode and change the instrument settings (see paragraph 8.1 and 8.2). It's not possible to enter the configuration MENU during a recording or an energy measurement.
- ☞ **START/STOP:** to record the **selected parameters** according to the instrument's settings (see chapter 10).

### 8.4.3. "HARM" mode

Selecting the HARM mode one of the below screens will be displayed according to the settings made as per paragraph 8.12. The screens show the harmonics (see paragraph 17.11) of the phase or phase-to-phase voltage.

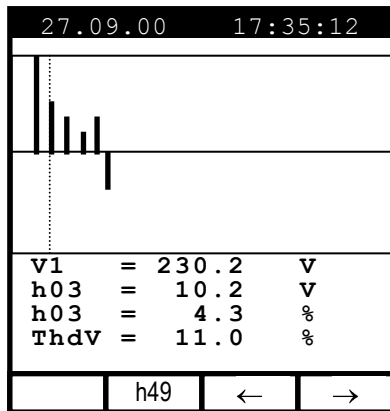

Example of screen in single-phase system

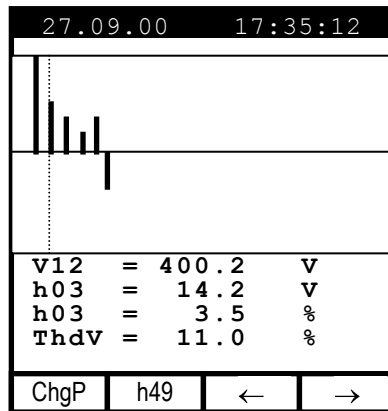

Example of screen in "3 wires" three-phase system

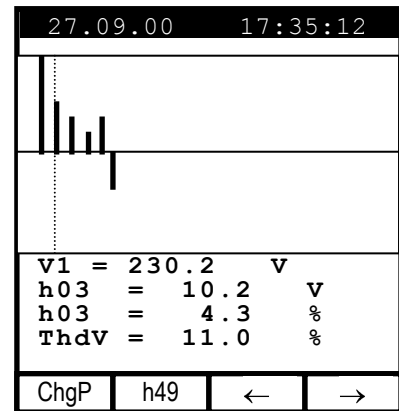

Example of screen in "4 wires" three-phase system

The symbols used are described in Table 7

For any message displayed see Appendix 1 – MESSAGES DISPLAYED.

The displayed histograms represent the harmonic content of the voltage under test. The value of the first harmonic h01 (fundamental at 50Hz) is not represented in scale along with the other harmonics in order to maximize the display of the latter. In case both voltage and current are connected to the instrument inputs, eventual negative values of the harmonics (therefore represented under the horizontal axis), indicate that such voltage harmonics are "generated" by the load.

Following keys are enabled:

- ☞ **F3, F4:** to move the cursor of the selected harmonic leftwards and rightwards respectively. At the same time the values relevant to the order no. of the selected harmonic and to the corresponding absolute and relative values (calculated on the basis of the fundamental) are updated.
- ☞ **F1** (only for three-phase mode): to display the values of the harmonics of the other voltages available. The voltage displayed is indicated above the F3 key.
- ☞ **F2:** to display the page of the harmonics h01 ÷ h24 (symbol **h24**) or that of the harmonics h25 ÷ h49 (symbol **h49**).
- ☞ **ESC:** to return back to METER mode (see paragraph 8.4.2).
- ☞ **SAVE:** to save in the instrument memory a record of "Smp" type (see paragraph 9.2) and the instantaneous values of voltage and current present on the instrument inputs. This function is disabled during a recording.
- ☞ **ENTER/HOLD:** to enable/disable the HOLD function (updating interruption) of the displayed data. All the previous functions remain however available. When the HOLD function is enabled, the word **HOLD** is displayed. When this function is enabled it's not possible to record or take an energy measurement. This function is disabled during a recording or an energy measurement.
- ☞ **MENU:** to enter in the **MENU** mode and change the instrument settings (see paragraph 8.1 and 8.2). It's not possible to enter the configuration MENU during a recording or an energy measurement.
- ☞ **START/STOP:** to record **selected parameters** according to the instrument's settings (see chapter 10).



#### 8.4.4. "WAVE" mode

Selecting the WAVE mode one of the below screens will be displayed according to the settings made as per paragraph 8.1. The screens show the waveform of the phase or phase-to-phase voltage.

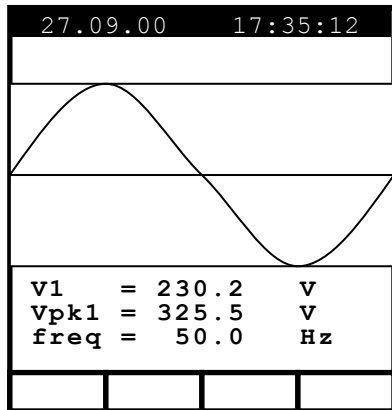

Example of screen in single-phase system

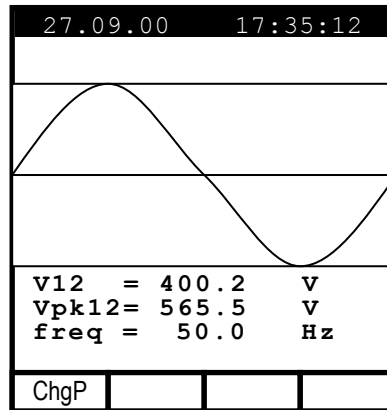

Example of screen in "3 wires" three-phase system

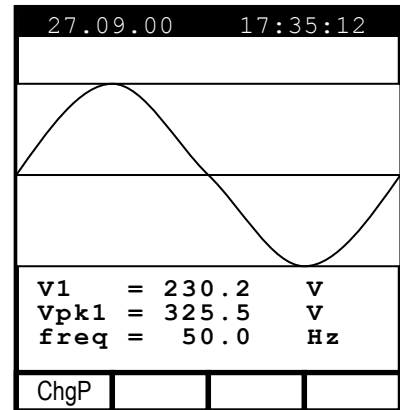

Example of screen in "4 wires" three-phase system

The symbols used are described in Table 7

For any message displayed see Appendix 1 – MESSAGES DISPLAYED.

Following keys are enabled:

- ☞ **F1:** (only for three-phase mode): to display the values corresponding to the following phase.
- ☞ **ESC:** to return back to METER mode (see paragraph 8.4.2).
- ☞ **SAVE:** to save in the instrument memory a record of "Smp" type (see paragraph 9.2) containing the instantaneous values of voltage and current present on the instrument inputs. This function is disabled during a recording.
- ☞ **ENTER/HOLD:** to enable/disable the HOLD function (updating interruption) of the displayed data. All the previous functions remain however available. When the HOLD function is enabled, the word **HOLD** is displayed. When this function is enabled it's not possible to record or take an energy measurement. This function is disabled during a recording or an energy measurement.
- ☞ **MENU:** to enter in the **MENU** mode and change the instrument settings (see paragraph 8.1 and 8.2). It's not possible to enter the configuration MENU during a recording or an energy measurement.
- ☞ **START/STOP:** to record **selected parameters** according to the instrument's settings (see chapter 10).

## 8.5. "CURRENT" FUNCTION

This function permits to display in real time the RMS value of AC/DC currents, the peak and Thdl value (see paragraph 17.11) of the 3 phase currents, the waveform and the harmonic spectrum of the 3 phase currents.

### 8.5.1. Symbols

The CURRENT position has three working modes:

- ✓ METER
- ✓ WAVE
- ✓ HARM

These modes will be described in detail in the next paragraphs.  
The symbols used are described below:

Symbol	Description
I1, I2, I3	RMS value of the current of phase 1, phase 2, phase 3 respectively
IN	RMS value of the current on the neutral
Ipk1, Ipk2, Ipk3	Peak value of the current of phase 1, phase 2, phase 3 respectively
h01 ÷ h49	Harmonic 01 ÷ harmonic 49.
Thdl	Total harmonic distortion factor of the current (see paragraph 17.11).
freq	Network frequency

Table 8: symbols used in the position CURRENT

### 8.5.2. "METER" mode

In this mode the instrument shows one of the screens below according to the settings made as per paragraph 8.1.

27.09.00		17:35:12	
CURRENT SINGLE PHASE			
I1	=	30.21	A
Ipk1	=	49.53	A
ThdI	=	23.06	%
freq	=	50.0	Hz
CLAMP TYPE: FlexINT			
HARM.	WAVE	PG-	PG+

Example of screen in single-phase mode

27.09.00		17:35:12	
CURRENT			
I1	=	30.21	A
I2	=	23.53	A
I3	=	23.06	A
freq	=	50.0	Hz
CLAMP TYPE: FlexINT			
HARM.	WAVE	PG-	PG+

Example of screen in "3 wires" three-phase mode

27.09.00		17:35:12	
CURRENT			
I1	=	30.21	A
I2	=	23.53	A
I3	=	23.06	A
IN	=	8.4	A
freq	=	50.0	Hz
CLAMP TYPE: FlexINT			
HARM.	WAVE	PG-	PG+

Example of screen in "4 wires" three-phase mode

The symbols used are described in Table 8

For any message displayed see Appendix 1 – MESSAGES DISPLAYED.

Following keys are enabled:

- ☞ **F1:** to pass to "HARMONIC" mode (see paragraph 8.5.3).
- ☞ **F2:** to pass to "WAVE" mode (see paragraph 8.5.4).
- ☞ **F3/F4:** to pass to previous/next function respectively.
- ☞ **SAVE:** to save in the instrument memory a record of "Smp" type (see paragraph 9.2) containing the instantaneous values of voltage and current present on the instrument inputs. This function is disabled during a recording.
- ☞ **ENTER/HOLD:** to enable/disable the HOLD function (updating interruption) of the displayed data. All the previous functions remain however available. When the HOLD function is enabled, the word **HOLD** is displayed. When this function is enabled it's not possible to record or take an energy measurement. This function is disabled during a recording or an energy measurement.
- ☞ **MENU:** to enter in the **MENU** mode and change the instrument settings (see paragraph 8.1 and 8.2). It's not possible to enter the configuration MENU during a recording or an energy measurement.
- ☞ **START/STOP:** to record **selected parameters** according to the instrument's settings (see chapter 10).

### 8.5.3. "HARM" mode

Selecting the HARM mode one of the screens below will be displayed according to the settings made as per paragraph 8.1. The screens show the harmonics (see paragraph 17.11) of the phase currents.

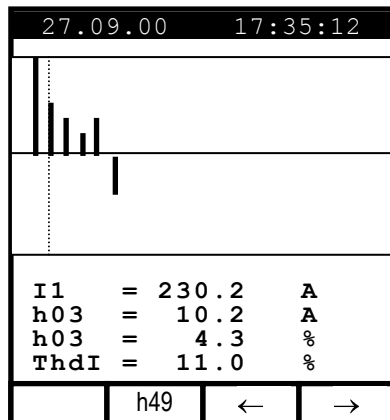

Example of screen in single-phase mode

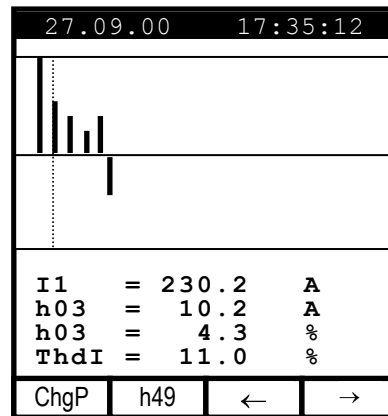

Example of screen in "3 wires" or "4 wires" three-phase mode

The symbols used are described in Table 8

For any message displayed see Appendix 1 – MESSAGES DISPLAYED.

The displayed histograms represent the harmonic content of the current under test. The value of the first harmonic h01 (primary at 50Hz) is not represented in scale along with the other harmonics in order to maximise the display of the latter. In case both voltage and current are connected to the instrument inputs, eventual negative values (therefore represented under the horizontal axis), indicate that such current harmonics are "generated" by the load.

Following keys are enabled:

- ☞ **F3, F4:** to move the cursor of the selected harmonic leftwards and rightwards respectively. At the same time the values relevant to the order no. of the selected harmonic and to the corresponding absolute and relative values (calculated on the basis of the fundamental) are updated.
- ☞ **F1** (only for three-phase mode): to display the values of the harmonics of the other voltages available. The voltage displayed is indicated above the F3 key.
- ☞ **F2:** to display the page of the harmonics h01 ÷ h24 (**h24** symbol) or that of the harmonics h25 ÷ h49 (**h49** symbol).
- ☞ **ESC:** to return back to METER mode (see paragraph 8.5.2)
- ☞ **SAVE:** to store in the instrument memory a record of "Smp" type (see paragraph 9.2) and the instantaneous values of voltage and current present on the instrument inputs. This function is disabled during a recording.
- ☞ **ENTER/HOLD:** to enable/disable the HOLD function (updating interruption) of the displayed data. All the previous functions remain however available. When the HOLD function is enabled, the word **HOLD** is displayed. When this function is enabled it's not possible to record or take an energy measurement. This function is disabled during a recording or an energy measurement.
- ☞ **MENU:** to enter in the **MENU** mode and change the instrument settings (see paragraph 8.1 and 8.2). It's not possible to enter the configuration MENU during a recording or an energy measurement.
- ☞ **START/STOP:** to record **selected parameters** according to the instrument's settings (see chapter 10).

#### 8.5.4. "WAVE" mode

Selecting the WAVE mode one of the below screens will be displayed according to the settings made as per paragraph 8.1. The screens show the waveform of the phase currents.

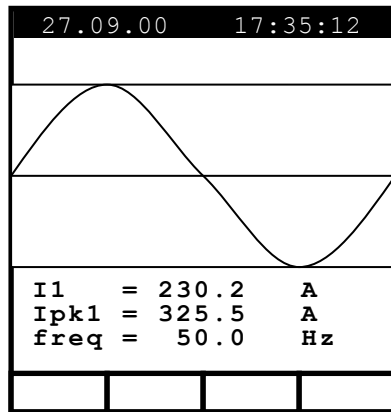

Example of screen in single-phase mode

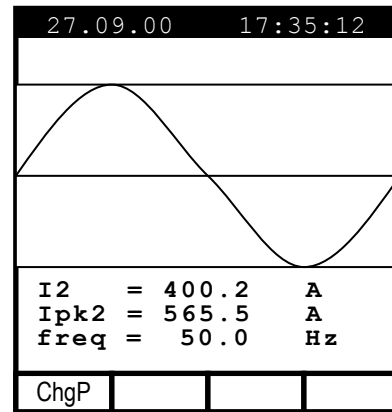

Example of screen in "3 wires" or "4 wires" three-phase mode

The symbols used are described in Table 8

For any message displayed see Appendix 1 – MESSAGES DISPLAYED.

Following keys are enabled:

- ☞ **F1:** (only for three-phase mode): to display the values relevant to the following phase.
- ☞ **ESC:** to return back to METER mode (see paragraph 8.5.2).
- ☞ **SAVE:** to save in the instrument memory a record of "Smp" type (see paragraph 9.2) containing the instantaneous values of voltage and current present on the instrument inputs. This function is disabled during a recording.
- ☞ **ENTER/HOLD:** to enable/disable the HOLD function (updating interruption) of the displayed data. All the previous functions remain however available. When the HOLD function is enabled, the word **HOLD** is displayed. When this function is enabled it's not possible to record or take an energy measurement. This function is disabled during a recording or an energy measurement.
- ☞ **MENU:** to enter in the **MENU** mode and change the instrument settings (see paragraph 8.1 and 8.2). It's not possible to enter the configuration MENU during a recording or an energy measurement.
- ☞ **START/STOP:** to record **selected parameters** according to the instrument's settings (see chapter 10).

## 8.6. "POWER" FUNCTION

This function permits you to display in real time the RMS value of AC/DC voltage, the peak and ThdV value of the 3 phase voltages, the waveform of the 3 phase voltages, the RMS value of AC/DC currents, the peak and ThdI of the 3 phase currents, the waveform of the 3 phase currents. Furthermore, the instrument calculates and displays the value of the phase and total active powers, the value of the phase and total reactive and apparent powers, the value of the phase and total power factors and  $\cos\phi$ .

### 8.6.1. Symbols

The position POWER has two working modes:

- ✓ METER
- ✓ WAVE

For voltage and current harmonics see paragraphs 8.4.3 and 8.5.3 respectively.

These modes will be described in detail in the next paragraphs.

The symbols used are described below:

Symbol	Description
V1, V2, V3	RMS value of the voltage of phase 1, phase 2, phase 3 respectively
V12, V23, V32, V31	RMS Value of the phase to phase voltages
freq	Network frequency
Phseq	Phase sequence indicator "123"→ correct "132"→ inverted "023"→ null voltage on the black wire "103"→ null voltage on the red wire "120"→ null voltage on the green wire "100"→ null voltages on the red and green wires "020"→ null voltages on the black and green wires "003"→ null voltages on the black and red wires
I1, I2, I3	RMS value of the current of phase 1, phase 2, phase 3 respectively
IN	RMS value of the current of the neutral
Pt, P1, P2, P3	Values of the active power (total, of phase 1, phase 2, phase 3 respectively)
P12, P32	(only for 3 wires measurement) Value of the power measured by the Wattmeter 1-2 and 3-2 respectively (see paragraph REF_Ref530397951 \r \h 17.12.2).
Qt, Q1, Q2, Q3	Values of the reactive power (total, of phase 1, phase 2, phase 3 respectively)
Q12, Q32	(only for 3 wires measurement) Value of the power measured by the VAR meter Va1-2 and 3-2 respectively (see paragraph REF_Ref530397951 \r \h 17.12.2).
St, S1, S2, S3	Values of the apparent power (total, of phase 1, phase 2, phase 3 respectively)
S12, S32	(only for 3 wires measurement) Value of the power measured by the VA meter Va1-2 and 3-2 respectively (see paragraph REF_Ref530397951 \r \h 17.12.2).
Pft, pf1, pf2, pf3	Values of the power factors (total, of phase 1, phase 2, phase 3 respectively)
dPft, dpf1, dpf2, dpf3	Value of the $\cos\phi$ (total, of phase 1, phase 2, phase 3 respectively)
Ead, Pd	Values of the Total Active Energy and Active Power On demand respectively

Table 9: symbols used in the position POWER

The symbols "i" and "c" stand for reactive powers (Q), power factors (Pf) and  $\cos\phi$  (dpf) respectively inductive and capacitive.

### 8.6.2. "METER" mode

In this mode the instrument shows one of the below screens according to the settings made as per paragraph 8.1.

27.09.00		17:35:12	
POWER SINGLE PHASE			
V1	=	230.0	V
I1	=	145.3	A
P1	=	32.91	kW
Q1	=	5.767	kVAR
S1	=	33.41	kVA
pf1	=	0.99	i
dpf1	=	0.99	i
WAVE		PG-	PG+

Example of screen in single-phase mode

27.09.00		17:35:12	
POWER THREE WIRE			
Pt	=	64.19	kW
Qt	=	10.99	kVAR
St	=	65.12	kVA
pft	=	0.99	i
dpft	=	1.00	i
ChgP		WAVE	PG-

Example of screen in "3 wires" three-phase mode

27.09.00		17:35:12	
POWER THREE PHASE			
Pt	=	135.8	kW
Qt	=	24.59	kVAR
St	=	138.0	kVA
pft	=	0.98	i
dpft	=	1.00	i
Phseq	=	123	
ChgP		WAVE	PG-

Example of screen in "4 wires" three-phase mode

The symbols used are described in Table 9

For any message displayed see Appendix 1 – MESSAGES DISPLAYED.

Following keys are enabled:

- ☞ **F1:** (only for three-phase measurement) to display cyclically the following screen (according to settings made as per paragraph 8.1):
  - ✓ Three-phase 3 wires: total three-phase values, Wattmeter phases 1-2 and 2-3 values, Peak Demand
  - ✓ Three-phase 4 wires: total three-phase values, phase1, phase2 and phase3 values, Peak Demand
- ☞ **F2:** to pass to "WAVE" mode (see paragraph 8.6.3).
- ☞ **F3/F4:** to pass to previous/next function respectively.
- ☞ **SAVE:** to save in the instrument memory a record of "Smp" type (see paragraph 9.2) and the instantaneous values of voltage and current present on the instrument inputs. This function is disabled during a recording.
- ☞ **ENTER/HOLD:** to enable/disable the HOLD function (updating interruption) of the displayed data. All the previous functions remain however available. When the HOLD function is enabled, the word **HOLD** is displayed. When this function is enabled it's not possible to record or take an energy measurement. This function is disabled during a recording or an energy measurement.
- ☞ **MENU:** to enter in the **MENU** mode and change the instrument settings (see paragraph 8.1 and 8.2). It's not possible to enter the configuration MENU during a recording or an energy measurement.
- ☞ **START/STOP:** to record **selected parameters** according to the instrument's settings (see chapter 10).

### 8.6.2.1. PEAK ENERGY DEMAND

In three-phase system selecting the POWER mode and pressing **F1** key 3 times you can reach the “Peak Demand” mode.

The “**Peak Demand**” screen shows the Max Average value of Active Power (and the corresponding Energy) measured during the last (or running) recording. The Average value is evaluated in the Integration Period set for the recording. This screen also shows the corresponding Active Energy and the corresponding Peak Date and Time.

27.09.00		17:35:12	
PEAK DEMAND THREE PHASE			
Ead	=	98.36	kWh
Pd	=	24.59	kW
Peak Date			
25.09.00 17:00			
Int Period: 15min			
Rec n: 06			
ChgP		PG-	PG+

Example of “PEAK ENERGY DEMAND” screen

- ☞ **F1:** to display the previous or the following screen. On the basis of the settings made as per paragraph 8.1 following screens are displayed cyclically:
  - ✓ Three-phase 3 wires: total three-phase values, Wattmeter phases 1-2 and 2-3 values, Peak Demand
  - ✓ Three-phase 4 wires: total three-phase values, phase1, phase2 and phase3 values, Peak Demand
- ☞ **F3/F4:** to pass to previous/next function respectively.
- ☞ **SAVE:** to save in the instrument memory a record of “Smp” type (see paragraph 9.2) and the instantaneous values of voltage and current present on the instrument inputs. This function is disabled during a recording.
- ☞ **ENTER/HOLD:** to enable/disable the HOLD function (updating interruption) of the displayed data. All the previous functions remain however available. When the HOLD function is enabled, the word **HOLD** is displayed. When this function is enabled it's not possible to record or take an energy measurement. This function is disabled during a recording or an energy measurement.
- ☞ **MENU:** to enter in the **MENU** mode and change the instrument settings (see paragraph 8.1 and 8.2). It's not possible to enter the configuration MENU during a recording or an energy measurement.
- ☞ **START/STOP:** to record **selected parameters** according to the instrument's settings (see chapter 10).



### 8.6.3. "WAVE" mode

Selecting the WAVE mode one of the below screens will be displayed according to the settings made as per paragraph 8.1. The screens show the waveform of the phase currents and the phase (or phase-to-phase) voltage.

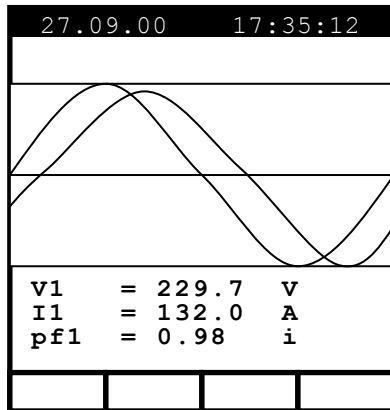

Example of screen in single-phase mode

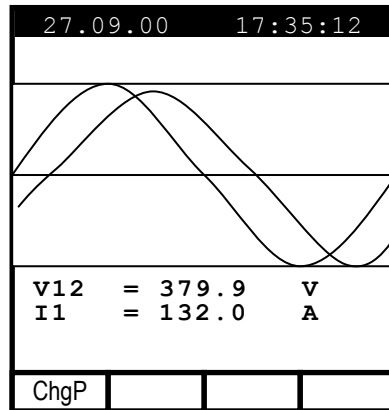

Example of screen in "3 wires" three-phase mode

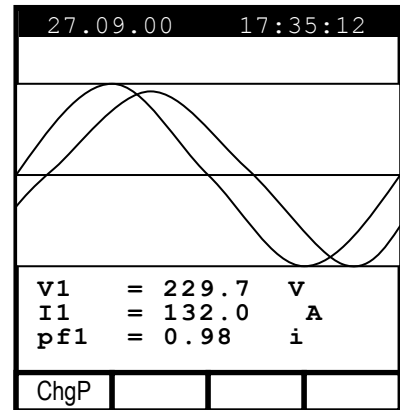

Example of screen in "4 wires" three-phase mode

The symbols used are described in Table 9

For any message displayed see Appendix 1 – MESSAGES DISPLAYED.

Following keys are enabled:

- ☞ **F1:** (only for three-phase mode): to display the values relevant to the following phase. On the basis of the settings made as per paragraph 8.1 following screens are displayed cyclically:
  - ✓ 3 wires three-phase: values of the Wattmeter 1-2, values of the wattmeter 2-3
  - ✓ 4 wires three-phase: values of phase 1, phase 2 and phase 3
- ☞ **ESC:** to return back to METER mode (see paragraph 8.6.2).
- ☞ **SAVE:** to save in the instrument memory a record of "Smp" type (see paragraph 9.2) containing the instantaneous values of voltage and current present on the instrument inputs. This function is disabled during a recording.
- ☞ **ENTER/HOLD:** to enable/disable the HOLD function (updating interruption) of the displayed data. All the previous functions remain however available. When the HOLD function is enabled, the word **HOLD** is displayed. When this function is enabled it's not possible to record or take an energy measurement. This function is disabled during a recording or an energy measurement.
- ☞ **MENU:** to enter in the **MENU** mode and change the instrument settings (see paragraph 8.1 and 8.2). It's not possible to enter the configuration MENU during a recording or an energy measurement.
- ☞ **START/STOP:** to record **selected parameters** according to the instrument's settings (see chapter 10).

## 8.7. "ENERGY" FUNCTION

This function permits to display the values of the phase and total active powers, the value of the phase and total capacitive and inductive reactive powers, the values of the power factors and phase and total  $\cos\varphi$ . Furthermore, the instrument is able to measure directly (see 8.7.2) the values of the phase and total active energies and the values of the phase and total capacitive and inductive reactive energies.

### 8.7.1. Symbols

The position ENERGY has only one working mode:

- ✓ METER

This mode will be described in detail in the next paragraphs.

The symbols used are described below:

Symbol	Description
Pt, P1, P2, P3	Values of the total active power, of phase 1, phase 2, phase 3 respectively
P12, P32	(only for 3 wires measurement) Value of the power measured by the Wattmeter 1-2 and 3-2 respectively (see paragraph REF_Ref530397951 \r \h 17.12.2)
Qt, Q1, Q2, Q3	Values of the total reactive power, of phase 1, phase 2, phase 3 respectively
Q12, Q32	(only for 3 wires measurement) Value of the power measured by the VARmeter 1-2 and 3-2 respectively (see paragraph REF_Ref530397951 \r \h 17.12.2)
St, S1, S2, S3	Values of the total apparent power, of phase 1, phase 2, phase 3 respectively
S12, S32	(only for 3 wires measurement) Value of the power measured by the VAmeter 1-2 and 3-2 respectively (see paragraph REF_Ref530397951 \r \h 17.12.2)
Eat, Ea1, Ea2, Ea3	Values of the total active energy, of phase 1, phase 2, phase 3 respectively
Erit, Eri1, Eri2, Eri3	Values of the total inductive reactive Energy, of phase 1, phase 2, phase 3 respectively
Erct, Erc1, Erc2, Erc3	Values of the total capacitive reactive Energy, of phase 1, phase 2, phase 3 respectively
dPft, dpf1, dpf2, dpf3	Value of the $\cos\varphi$ (total, of phase 1, phase 2, phase 3 respectively)

Table 10: symbols used in the position ENERGY

The symbols "i" and "c" stand for reactive powers (Q) and energies (Er) inductive and capacitive respectively.

### 8.7.2. "METER" mode

In this mode the instrument shows one of the below screens according to the settings made as per paragraph 8.1.

27.09.00		17:35:12	
ENERGY SINGLE PHASE			
Ea1	=	0.000	kWh
Erc1	=	0.000	kVARh
Eri1	=	0.000	kVARh
P1	=	36.38	kW
Q1	=	6.375	kVAR
S1	=	36.94	kVA
dpf1	=	0.98	i
Meas Time:	=	00:00:00	
	MEAS	PG-	PG+

Example of screen in single-phase mode

27.09.00		17:35:12	
ENERGY THREE PHASE			
Eat	=	0.000	kWh
Erct	=	0.000	kVARh
Erit	=	0.000	kVARh
Pt	=	36.38	kW
Qt	=	6.375	kVAR
St	=	36.94	kVA
dpft	=	0.98	i
Meas Time:	=	00:00:00	
	MEAS	PG-	PG+

Example of screen in "3 wires" three-phase mode

27.09.00		17:35:12	
ENERGY THREE PHASE			
Eat	=	0.000	kWh
Erct	=	0.000	kVARh
Erit	=	0.000	kVARh
Pt	=	167.7	kW
Qt	=	30.47	kVAR
St	=	170.4	kVA
dpft	=	0.98	i
Meas Time:	=	00:00:00	
ChgP	MEAS	PG-	PG+

Example of screen in "4 wires" three-phase mode

The symbols used are described in Table 10.

For any message displayed see Appendix 1 – MESSAGES DISPLAYED.

Following keys are enabled:

- ☞ **F2:** to start / stop immediately a **direct energy measurement**. The energy counters will start increasing proportionally to the active power absorbed by the load.  
**The results obtained cannot be memorised.**  
**If the active power is negative the counters will not increase.**
- ☞ **F1:** (only for 4 wires measurement) to display the following screen. On the basis of the settings made as per paragraph 8.1 following screens are displayed cyclically:  
Overall three-phase values, values of phase 1, phase 2 and phase 3
- ☞ **F3/F4:** to pass to previous/next function respectively.
- ☞ **SAVE:** to save in the instrument memory a record of "Smp" type (see paragraph 9.2) containing the instantaneous values of voltage and current present on the instrument inputs. This function is disabled during a recording.
- ☞ **ENTER/HOLD:** to enable/disable the HOLD function (updating interruption) of the displayed data. All the previous functions remain however available. When the HOLD function is enabled, the word **HOLD** is displayed. When this function is enabled it's not possible to record or take an energy measurement. This function is disabled during a recording or an energy measurement.
- ☞ **MENU:** to enter in the **MENU** mode and change the instrument settings (see paragraph 8.1 and 8.2). It's not possible to enter the configuration MENU during a recording or an energy measurement.
- ☞ **START/STOP:** to record **selected parameters** according to the instrument's settings (see chapter 10).

## 8.8. MEASURING PROCEDURES

### 8.8.1. Using the Instrument in a Single Phase System



#### WARNING

The maximum voltage between B1 and B4 inputs is 600 V~ (CATII) / 350V~ phase – earth or 600V~ (CATIII) / 300 V~ phase to earth. Do not measure voltages exceeding the limits prescribed by this manual. Should you exceed the voltage limits you could damage the instrument and/or its components or endanger your safety.

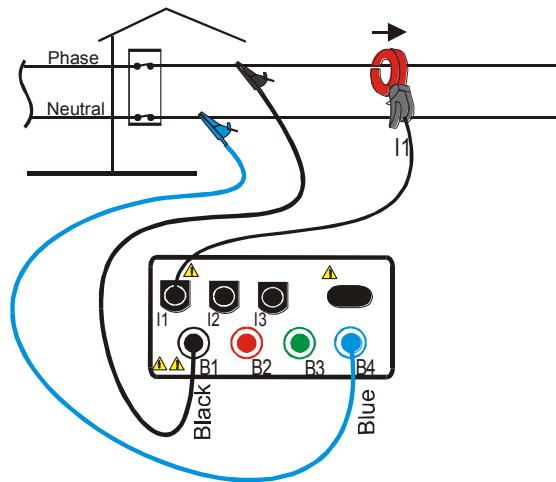

Instrument connection in a single-phase system

#### WARNING



If possible, before connecting the instrument to the electrical equipment to be tested take the power supply off the electrical equipment.

1. Check, and if needed modify, the basic settings of the instrument (see paragraphs 8.1 and 8.2). Particularly, the **single-phase** mode must be set.
2. Select the working mode corresponding to the type of analysis desired. In case of doubts select the **POWER** working mode (see paragraph 8.6).
3. Connect the phase and neutral voltage wires respecting the connections shown in the picture.
4. If you want to measure current and power, connect the clamp meter to the phase conductor respecting the specifications shown on the clamp and the connections shown in the picture.  
In case of doubts select the **POWER** working mode and check if the active power P is positive. If it's negative, remove current transducer from the wire and reconnect it so the transducer label faces the opposite direction.
5. Apply voltage to the electrical equipment under test (if previously shut off for the instrument connection).
6. The values of the available electrical parameters will be displayed on the display of the instrument. For further details see the paragraph relevant to the position of the switch.
7. You can press **HOLD** to interrupt the updating in real time of the displayed values.
8. You can press **SAVE** to save the displayed values (see paragraph 9.2).
9. If you want to record:
  - a) Check, and if needed modify, the values of the basic parameters (see par. 8.1 and 8.2).
  - b) Check, and if needed modify, the recording parameters by pressing **MENU** (see the paragraph corresponding to the position of the rotary switch selected).
  - c) To start the recording press **START** (see chapter 10.1).

## 8.8.2. Using the Instrument in a Three Phase 4 Wire System



### WARNING

The maximum voltage between B1, B2, B3, B4 inputs is 600 V~ (CATII) / 350V~ phase – earth or 600V~ (CATIII) / 300 V~ phase to earth.

Do not measure voltages exceeding the limits prescribed by this manual. Should you exceed the voltage limits you could damage the instrument and/or its components or endanger your safety.

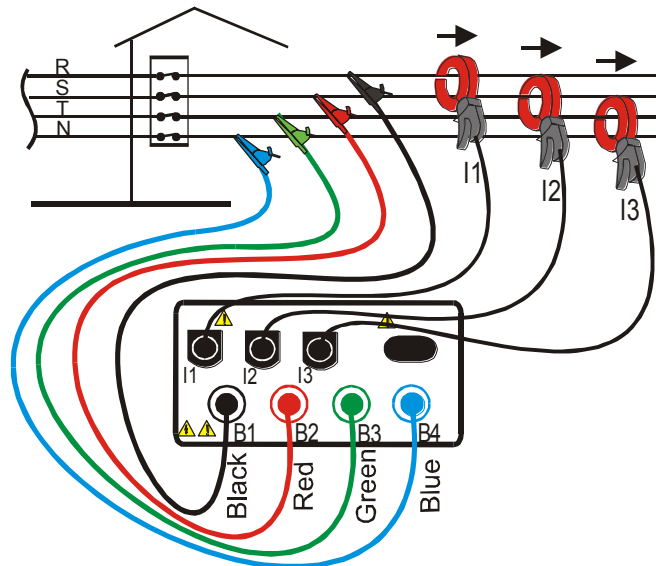

Instrument connection in a three-phase 4 wire system

### WARNING



If possible, before connecting the instrument to the electrical equipment to be tested take the power supply off the electrical equipment.

1. Check, and if needed modify, the basic settings of the instrument (see paragraphs 8.1 and 8.2). Particularly, the **3PH4W** mode must be set.
2. Select the working mode corresponding to the type of analysis desired. In case of doubts select the **POWER** working mode (see paragraph 8.6).
3. Connect the phase and neutral voltage wires respecting the connections shown in the picture.
4. If you want to measure current and power, connect the clamp meter to the phase conductor respecting the specifications shown on the clamp and the connections shown in the picture. In case of doubts select the **POWER** working mode and, connecting one clamp at a time, check if:
  - a) the phase sequence is correct (see paragraph 8.4.2).
  - b) the active power  $P$  of each phase is positive. If it's negative, remove current transducer from the wire and reconnect it so the transducer label faces the opposite direction.
  - c) the value of the  $Pf$  of each phase is not excessively low (typically it's not lower than 0.4). In case the  $Pf$  is lower than 0.4, check if the phase voltage is associated to the right clamp meter (for example the voltage of phase 1 must be associated to the clamp meter no. 1).
5. Apply voltage to the electrical equipment under test (if previously shut off for the instrument connection).

6. The values of the available electrical parameters will be displayed. For further details see the paragraph relevant to the position of the switch.
7. You can eventually press **HOLD** to interrupt the updating in real time of the displayed values.
8. You can press **SAVE** to save the displayed values (see paragraph 9.2).
9. If you want to record:
  - a) Check and, if needed, modify the values of the basic parameters (see paragraphs 8.1 and 8.2).
  - b) Check and, if needed, modify the recording parameters by pressing **MENU** (see the paragraph corresponding to the position of the rotary switch selected).
  - c) To start the recording press **START** (see chapter 10.1).

### 8.8.3. Using the Instrument in a Three Phase 3 Wire System



#### WARNING

The maximum voltage between B1 and B4 inputs is 600 V~ (CATII) / 350V~ phase – earth or 600V~ (CATIII) / 300 V~ phase to earth. Do not measure voltages exceeding the limits prescribed by this manual. Should you exceed the voltage limits you could damage the instrument and/or its components or endanger your safety.

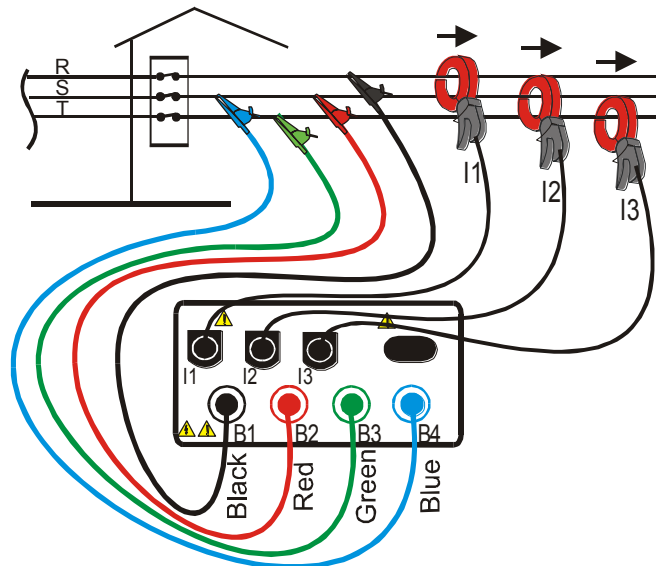

Instrument connection in a 3 wires three-phase system



#### WARNING

Please note that in this case the Blue cable (neutral) is connected with the Red cable on phase 2.



#### WARNING

If possible, before connecting the instrument to the electrical equipment to be tested take the power supply off the electrical equipment.

1. Check, and if needed modify, the basic settings of the instrument (see paragraphs 8.1 and 8.2). Particularly, the **3 wires** mode must be set.
2. Select the working mode corresponding to the type of analysis desired. In case of doubts select the **POWER** working mode (see paragraph 8.6).
3. Connect the phase and neutral voltage wires respecting the connections shown in the picture.
4. If you want to measure current and power, connect the clamp meter to the phase conductor respecting the specifications shown on the clamp and the connections shown in the picture. In case of doubts set **temporarily** the **3PH4W** mode, then select the **POWER** working mode, connect the blue wire of the instrument to earth and, connecting one clamp at a time, check if:
  - a) The phase sequence is correct (see paragraph 8.4.2).

- b) The active power  $P$  of each phase is positive. If negative, turn the clamp of the phase in question.
  - c) The value of the  $Pf$  of each phase is not excessively low (typically it's not lower than 0.4). In case the  $Pf$  is lower than 0.4, check if the phase voltage is associated to the right clamp meter (for example the voltage of phase 1 must be associated to the clamp meter no. 1).
  - d) After checking, and if needed modifying, the connection of the instrument to the equipment re-set the **3 wires** mode and the connections shown in the picture (blue and red wire together).
5. Apply voltage to the electrical equipment under test (if previously shut off for the instrument connection).
  6. The values of the available electrical parameters will be displayed of the instrument. For further details see the paragraph relevant to the position of the switch.
  7. You can press **HOLD** to interrupt the updating in real time of the displayed values.
  8. You can press **SAVE** to save the displayed values (see paragraph 9.2).
  9. If you want to record:
    - a) Check and eventually modify the values of the basic parameters (see paragraphs 8.1 and 8.2).
    - b) Check and eventually modify the recording parameters by pressing **MENU** (see the paragraph corresponding to the position of the rotary switch selected).
    - c) To start the recording press **START** (see chapter 10.1).



## 9. SAVING RESULTS

The **SAVE** button can be used to store the displayed results related to the rotary switch position:

- ✓ **SAFETY TEST** and for **AUX** rotary switch position: pressing this key the instrument will store the displayed result generating a corresponding record in the SAFETY TEST MEMORY (see paragraph 11.1)
- ✓ **ANALYSER** rotary switch position: pressing this key the instrument will store the displayed result generating a "Smp" record in the ANALYSER MEMORY (see paragraph 11.2)

Please note that Saving results is different from recording.

### 9.1. SAVING SAFETY TEST RESULTS

After a **SAFETY TEST** (function  $LOW\Omega$ ,  $M\Omega$ , RCD, LOOP, EARTH) or during a real time measurement in **AUX** position the user can press the **SAVE** button to store the displayed result.

☞ The REMINDER PLACE parameter isn't related to Measurement Order Number and can help the user to remind the place where he performed the measurement.

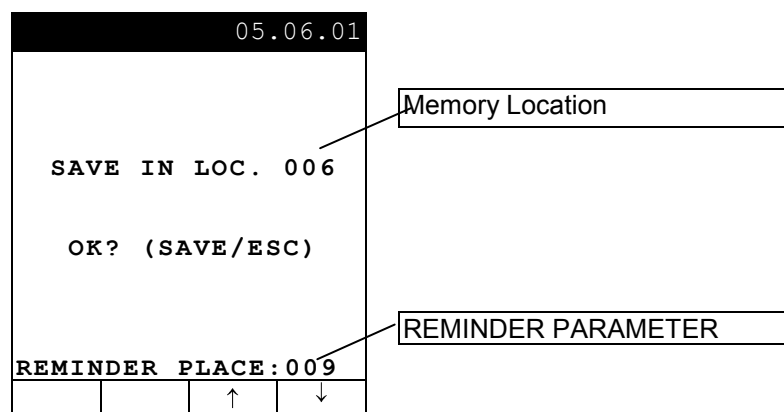

The following keys are available:

- ☞ **F3, F4**: to adjust the REMINDER PLACE.
- ☞ **SAVE**: to store the test result associating to the actual REMINDER PLACE
- ☞ **ESC**: to quit this mode without saving.

### 9.2. SAVING DISPLAYED VALUES OF ANALYSER FUNCTION

During a Real Time measurement (in **ANALYSER** function) if the user press the **SAVE** button, a "Smp" record will be generate in the "ANALYSER MEMORY". This file contains the Voltage and Current values present at instrument's input when the user pressed the **SAVE** key.

Downloading these values to a PC (using the management Software) the Power, Energy, Harmonics, etc values can be calculated and displayed as well.

## 10. RECORDINGS

### 10.1. START A RECORDING

The recording function is available for **ANALYSER** and **AUX** rotary switch position. As you can read in the paragraphs 7.2.1 and 8.2, a recording can be started manually or automatically. Therefore, after setting all the parameters **and leaving the Menu**, the instrument will start to record:

- ✓ **MANUALLY:** the recording will start when Instrument time reach the "00" seconds value after pressing **START/STOP**.
- ✓ **AUTOMATICALLY:** **If the operator has pressed START/STOP** the instrument will remain in stand-by until the date and time previously set, then the recording will start. **While if the operator doesn't press START/STOP the recording will never start.**



#### WARNING

For recordings **we recommend to use the external power supply adapter** (code A0050 optional for GSC57) even the instrument allows the operator to perform a recording using internal batteries.

If you press **START** key, a recording without the external power supply adapter (code A0050) the instrument will display a warning message "**No ext supply**". Press **START** key again to run the recording or press **ESC** to quit.

If during a recording the external power supply adapter (code A0050 optional for GSC57) is de-energised, the instrument will continue the recording using the internal battery power until the batteries are exhausted (the data stored until the definitive turning off won't get lost). For this we recommend you **ALWAYS insert a new set of batteries before a long recording**.

The instrument uses sophisticated algorithms to prolong the battery life. Particularly:

- ✓ The instrument switches OFF the backlight Automatically after 5 seconds.
- ✓ If the Battery level is too low the Backlight function will be disabled.
- ✓ If the instrument is just displaying in real time (and the external power supply is not connected), after about 5 minutes from the last key pressure or switch rotation the instrument turns off automatically ("AUTOPOWER OFF" function).
- ✓ If the instrument is recording or is measuring energy (and the external power supply is not connected), after about 5 minutes from the last key pressure or switch rotation the instrument starts a special procedure to save the batteries ("ECONOMY MODE"): the instrument keeps recording but the display is turned off.

Before starting a recording the operator should first evaluate the state of the equipment, decide what to record and set the instrument accordingly.

**In order to facilitate this task we have decided to supply the instrument pre-set with a general configuration which should fit most cases.**

## 10.2. SETTING TYPICAL CONFIGURATIONS

In order to facilitate this task, the instrument is provided of the following two pre-setting recording modes:

1. **Default Configuration:** it's comprehensive which should fit most cases.
2. **Typical Configuration:** it's possible to select recording with pre-setting parameters for the following situations:

<b>EN50160</b>	Setting parameters for Networks Quality in compliance with EN 50160 standard (see paragraph 17.11.2).
<b>SURGES &amp; DIPS</b>	Setting parameters for Voltage Anomalies detection (surges, dips, break, etc.) (see paragraph 17.10).
<b>HARMONICS</b>	Setting parameters for Harmonics Analysis of Voltage and Current (see paragraph 17.11).
<b>START-UP</b>	Setting parameters for Start-Up motors and electrical devices.
<b>POWER &amp; ENERGY</b>	Setting parameters for Power and Energy measures (see paragraph 17.12).

### 10.2.1. Default Configuration

The default configuration of instrument consists in the following parameters settings:

✓ **ANALYSER CONFIG:**

System:	3PH4W
Frequency:	50Hz
Current Range:	1000A
Clamp Type:	FlexINT
Transforming ratio of voltmetric transformers:	1
Password:	OFF

✓ **RECORDER CONFIG:**

Start:	MANU (the recording is started 1 minute after pressing the <b>START/STOP</b> key)
Stop:	MANU
Integration period:	15min
Recording of harmonics:	ON
Recording of Voltage anomalies (voltage Sag and Surge) :	ON
Voltage Reference for Sag and Surge detection:	230V
Upper Limit for Sag and Surge detection:	6%
Lower Limit for Sag and Surge detection:	10%
Selected voltages:	V1, V2, V3
Selected voltage harmonics:	THD, 01, 03, 05, 07
Selected currents:	I1, I2, I3, IN
Selected current harmonics:	THD, 01, 03, 05, 07
CO-GENERATION:	OFF
Powers, Pf and $\cos\phi$ selected:	Pt, P1, P2, P3 Qti, Q1i, Q2i, Q3i Qtc, Q1c, Q2c, Q3c St, S1, S2, S3 Pft, Pf1, Pf2, Pf3 dpft, dpf1, dpf2, dpf3
Energies:	Eat, Ea1, Ea2, Ea3 Erit, Eri1, Eri2, Eri3 Erct, Erc1, Erc2, Erc3

If the user changed the instrument's settings can quickly resume the above configuration using the RESET option (see paragraph 5.4).

By pressing **START/STOP** the recording of the selected parameters is started according to the settings made in the MENU (see paragraphs 8.1 and 8.2). The rotary switch position doesn't affect the recording setting.

As the default value of the integration periods is set at 15 minutes the instrument will store data in the temporary memory for 15 minutes. Afterwards the instrument will elaborate the results saved in the temporary memory and will save the result of this elaboration (min, avg, and max values) in the definitive memory. Therefore, if an integration period of 15 minutes has been set, the recording will continue for about 15 minutes before producing a series of recorded values. If the recording is interrupted before the selected integration period has completely elapsed the data stored in the temporary memory will not be elaborated and the corresponding series of values won't be transferred to the definitive memory.

### 10.2.2. Typical Configurations

To activate the Typical Configurations, follow this procedure:

1. Turn the rotary switch on "**ANALYSER**".
2. Press **MENU** key. The instrument shows the following screen:

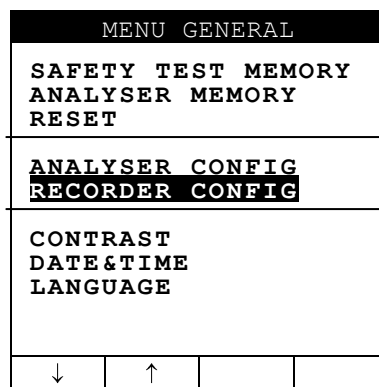

3. Press **MENU** key again. The instrument displays a screen as shown below (picture on the left). This way is possible to select the desired configuration with **F1** or **F2** key.

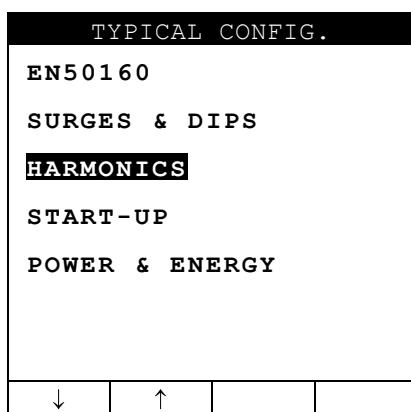

Configuration selection

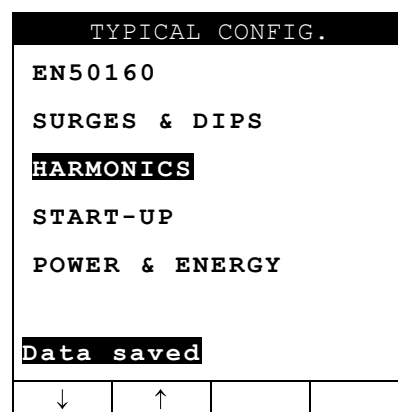

Confirmation configuration selection

4. Press **ENTER** key. The instrument displays the message “**Data saved**” for a while to confirm the desired configuration (see above on the right). The instrument return to the measure mode.

Below you can find the parameters for each of **5 Typical Configurations**:

<b>EN50160</b>
----------------

- ✓ ANALYSER CONFIG:
 

System:	not modified
Frequency:	not modified
Current Range:	not modified
Clamp Type:	not modified
TV Ratio:	not modified
Password:	not modified
  
- ✓ RECORDER CONFIG:
 

Start:	MANU
Stop:	MANU
Integration period:	10min
Recording of harmonics:	ON
Recording of Voltage anomalies (voltage Surge and Dips) :	ON
Voltage Reference for Dips and Surge detection:	230V(single, 3ph4w); 400V(3ph3w)
Upper Limit for Dips and Surge detection:	6%
Lower Limit for Dips and Surge detection:	10%
Selected voltages:	V1(single); V12,V32,V31(3ph3w); V1,V2,V3 (3ph4w)
Selected voltage harmonics:	THD,DC,01,02,03,04,05, ... 25 (single,3ph3w); THD, 01,02,03,04,05,06,07,08,09,10,11,13,15,17,19,21,23,25 (3ph4w)
CO-GENERATION:	OFF

<b>SURGES &amp; DIPS</b>
--------------------------

- ✓ ANALYSER CONFIG:
 

System:	not modified
Frequency:	not modified
Current Range:	not modified
Clamp Type:	not modified
TV Ratio:	not modified
Password:	not modified
  
- ✓ RECORDER CONFIG:
 

Start:	MANU
Stop:	MANU
Integration period:	1min
Recording of harmonics:	OFF
Recording of Voltage anomalies (voltage Surge and Dips) :	ON
Voltage Reference for Dips and Surge detection:	230V(single, 3ph4w); 400V(3ph3w)
Upper Limit for Dips and Surge detection:	6%
Lower Limit for Dips and Surge detection:	10%
Selected voltages:	V1(single); V12,V32,V31(3ph3w); V1,V2,V3, V12,V32,V31(3ph4w)
Selected current:	I1 (single); I1,I2,I3 (3ph3w, 3ph4w);
CO-GENERATION:	OFF

## HARMONICS

- ✓ ANALYSER CONFIG:
- |                |              |
|----------------|--------------|
| System:        | not modified |
| Frequency:     | not modified |
| Current Range: | not modified |
| Clamp Type:    | not modified |
| TV Ratio:      | not modified |
| Password:      | not modified |
- ✓ RECORDER CONFIG:
- |                                                           |                                                                                     |
|-----------------------------------------------------------|-------------------------------------------------------------------------------------|
| Start:                                                    | MANU                                                                                |
| Stop:                                                     | MANU                                                                                |
| Integration period:                                       | 10min                                                                               |
| Recording of harmonics:                                   | ON                                                                                  |
| Recording of Voltage anomalies (voltage Surge and Dips) : | OFF                                                                                 |
| Selected voltages:                                        | V1(single); V12,V32,V31(3ph3w); V1,V2,V3 (3ph4w)                                    |
| Sel. Voltage harmonics:                                   | THD,DC,01,03,...25 (single); THD,DC,01,03,...17 (3ph3w); THD,DC,01,03,...13 (3ph4w) |
| Selected current:                                         | I1 (single); I1,I2,I3 (3ph3w); I1,I2,I3,In (3ph4w)                                  |
| Sel. Current harmonics:                                   | THD,DC,01,03,...25 (single); THD,DC,01,03,...17 (3ph3w); THD,DC,01,03,...13 (3ph4w) |
| CO-GENERATION:                                            | OFF                                                                                 |

## START-UP

- ✓ ANALYSER CONFIG:
- |                |              |
|----------------|--------------|
| System:        | not modified |
| Frequency:     | not modified |
| Current Range: | not modified |
| Clamp Type:    | not modified |
| TV Ratio:      | not modified |
| Password:      | not modified |
- ✓ RECORDER CONFIG:
- |                                                          |                                                                                                           |
|----------------------------------------------------------|-----------------------------------------------------------------------------------------------------------|
| Start:                                                   | MANU                                                                                                      |
| Stop:                                                    | MANU                                                                                                      |
| Integration period:                                      | 5sec                                                                                                      |
| Recording of harmonics:                                  | ON                                                                                                        |
| Recording of Voltage anomalies (voltage Surge and Dips): | ON                                                                                                        |
| Voltage Reference for Dips and Surge detection:          | 230V(single, 3ph4w); 400V(3ph3w)                                                                          |
| Upper Limit for Dips and Surge detection:                | 6%                                                                                                        |
| Lower Limit for Dips and Surge detection:                | 10%                                                                                                       |
| Selected voltages:                                       | V1(single); V12,V32,V31(3ph3w); V1,V2,V3 (3ph4w)                                                          |
| Sel. Voltage harmonics:                                  | THD,01,03,...15 (single, 3ph3w); THD,01,03,...11 (3ph4w);                                                 |
| Selected current:                                        | I1 (single); I1,I2,I3 (3ph3w); I1,I2,I3,In (3ph4w);                                                       |
| Sel. Current harmonics:                                  | THD,01,03,...15 (single, 3ph3w); THD,01,03,...11 (3ph4w);                                                 |
| CO-GENERATION:                                           | OFF                                                                                                       |
| Power, Pf, cosφ selected:                                | P1,Q1i,Q1c,S1,Pf1,DPf1(single); Pt,Qti,Qtc,St,Pft,DPft (3ph3w)<br>Pt,P1,P2,P3,Qti,Qtc,St,Pft,DPft (3ph4w) |
| Energies:                                                | Ea1,Eri1,Erc1(single); Eat, Erit, Erct (3ph3w); Eat, Ea1, Ea2,Ea3,Erit, Erct (3ph4w)                      |

<b>POWER &amp; ENERGY</b>
---------------------------

✓ ANALYSER CONFIG:	
System:	not modified
Frequency:	not modified
Current Range:	not modified
Clamp Type:	not modified
TV Ratio:	not modified
Password:	not modified
✓ RECORDER CONFIG:	
Start:	MANU
Stop:	MANU
Integration period:	15min
Recording of harmonics:	OFF
Recording of Voltage anomalies (voltage Surge and Dips) :	OFF
Selected voltages:	V1(single); V12,V32,V31(3ph3w); V1,V2,V3, V12,V32,V31 (3ph4w)
Selected current:	I1 (single); I1,I2,I3 (3ph3w); I1,I2,I3,In (3ph4w);
CO-GENERATION:	ON
Power, Pf, cosφ selected:	P1,Q1i,Q1c,S1,Pf1,DPf1(single); Pt,P12,P23,Qti,Q12i,Q23i,Qtc,Q12c,Q23c,St,S12,S23,Pft,DPf (3ph3w) Pt,P1,P2,P3,Qti,Q1i,Q2i,Q3i,Qtc,Q1c,Q2c,Q3ct,St,S1,S2,S3,Pft,Pf1,Pf2;Pf3,DPft,DPf1,DPf2,DPf3 (3ph4w)
Energies:	Ea1,Eri1,Erc1(single); Eat, Erit, Erct (3ph3w) ; Eat,Ea1,Ea2,Ea3,Erit,Eri1,Eri2,Eri3,Erct,Erc1,Erc2,Erc3 (3ph4w)

By pressing **START/STOP** the recording of the selected parameters is started according to the settings made for each Typical Configuration. The rotary switch position doesn't affect the recording setting.

### 10.3. DURING A RECORDING

If during a recording the external power supply is de-energised, the instrument will continue the recording using the internal battery power until the batteries are exhausted (the data stored up to the point the instrument shuts down won't get lost). For this we recommend you **ALWAYS insert a new set of batteries before a long recording**.

The instrument uses sophisticated algorithms to prolong the battery life. Particularly if the instrument is recording or is measuring energy (and the external power supply is not connected), after about 5 minutes from the last key pressure or switch rotation the instrument starts a special procedure to save the batteries ("ECONOMY MODE"): the instrument keeps recording but the display is turned off.

During a recording the following are disabled:

- ✓ **AUTOPOWER OFF function**
- ✓ **ON/OFF key**
- ✓ **HOLD key**
- ✓ **SAVE key**

#### 10.3.1. MENU key

If you press the **MENU** key during a recording the following screen will appear:

```

INFO REC n XX
START
09.18.01  11:35
STOP
13.18.01  12:00
INT PERIOD: 15min
REC PERIODS:00004
REC TIME:139d.02h
HARM REC: (ON)
ANOM REC: (ON)
N ANOMALIES: 00000
Recording
    
```

This page includes:

1. START Date and Time
2. STOP Date and Time (or Manual).
3. Integration Period
4. Actual Number of Elapsed Integration Periods
5. Actual Recording Time
6. Status of Harmonic Flag
7. Status of Voltage Anomalies Flag
8. Number of Voltage anomalies occurred during the recording



### 10.3.2. Rotary Switch during a recording

If You move the rotary switch during a recording the following screen will appear:



This page means that a recording is running but the actual rotary switch position doesn't correspond to this.

The instrument will continue to record.

#### **10.4. STOPPING A RECORDING OR AN ENERGY MEASUREMENT**

The instrument uses a protective routine to avoid the risk of being disturbed or interrupted during a recording or an energy measurement. Once a recording or a direct energy measurement (see paragraph 8.7.2) has been started (with the option PASSWORD enabled), after about 3 minutes from the last key pressure or switch rotation it won't be sufficient to press **START/STOP** (if a recording is running) or **F2** (if an energy measuring is running) to stop the recording, it will be necessary to insert the password.

In order to insert the password (which is not changeable), press the multifunction keys in the following sequence (within 10 seconds):

**F1, F4, F3, F2**

In order to enable/disable this option see paragraph 8.1.6.

If a wrong password is inserted, the instrument will display an error message and will repeat the request.

If no key is pressed after about 10 seconds the instrument returns back to the original screen.

## 11. INSTRUMENT'S MEMORY

By pressing the **MENU** key the following screen will be displayed:

MENU GENERAL			
<b>SAFETY TEST MEMORY</b>			
ANALYSER MEMORY			
RESET			
ANALYSER CONFIG			
RECORDER CONFIG			
CONTRAST			
DATE & TIME			
LANGUAGE			
↓	↑		

It's not possible to enter the **MENU** during a recording or a Real Time Energy measurement.

### 11.1. SAFETY TEST MEMORY

Selecting the SAFETY TEST MEMORY item and pressing **ENTER** the instrument display the following screen:

SAFETY TEST MEMORY		
MEM	TYPE	PLACE
001	LOW $\Omega$	003
002	EARTH	003
003	LOW $\Omega$ 10A	004
004	M $\Omega$	004
005	RCD	004
TOT: 005 FREE: 994		
↑	↓	LAST ALL

Example of SAFETY TEST MEMORY screen

- ✓ MEM: **Order Number of the measurement**
- ✓ TYPE: Measurement TYPE
- ✓ PLACE: Mnemonic parameter associated by User to Measurement
- ✓ TOT: Total Number of Measurement
- ✓ FREE: Available Memory Location

Following keys are enabled:

- ☞ **F1, F2:** (to select the Measurement).
- ☞ **F3:** to cancel the last recording effected.
- ☞ **F4:** to cancel all the recordings effected.
- ☞ **ENTER:** to see the measurement results of the selected test
- ☞ **ESC:** to quit this mode

## 11.2. ANALYSER MEMORY

This option permits you to display:

- ✓ The present content of the instrument memory
- ✓ The size of the memorised data
- ✓ The residual space available for future recordings (expressed in days and hours)

**All the stored data can be displayed and analysed only downloading them into a PC with the operating software.**

After selecting “ANALYSER MEMORY” from the Main Menu the screen below will be displayed

ANALYSER MEMORY			
01	Smp	02.01	01:23
02	Rec	02.01-02.01	
03	R&a	02.01-02.01	
04	Rec	02.01-02.01	
05	R&a	02.01-02.01	
06	Rec	04.01-05.01	
DATA SIZE: 0.11Mb			
REC TIME: 0d.06h			
↑	↓	LAST	ALL

**Example of ANALYSER MEMORY screen**

- ✓ Rec: **recordings** effected with respective Start and Stop dates expressed in the format “day. month” (start) – “day. month” (stop) **without** Voltage Sag and Surge detection.
- ✓ R&a: **recordings** effected with respective Start and Stop dates expressed in the format “day. month” (start) – “day. month” (stop) **with** Voltage Anomalies (Sag and Surge) detection .
- ✓ Smp: values of the **samples** of voltage and current stored by pressing **SAVE**.
- ✓ DATA SIZE: dimensions of the data saved in the instrument memory.
- ✓ REC TIME: amount of memory available, calculated on the basis of the parameters selected for recording, therefore the most complete one (expressed in the format “days. hours”) to make recordings.

The maximum quantity of Rec + R&a + Smp which can be contained by the instrument is **35**.

Following keys are enabled:

- ☞ **F1, F2:** (only if the quantity of Rec+R&a+Smp is higher than 7) to run over all the recordings stored in the instrument memory.
- ☞ **F3:** to cancel the last recording effected.
- ☞ **F4:** to cancel all the recordings effected.
- ☞ **ESC:** to quit this mode

## 12. CONNECTING THE INSTRUMENT TO A PC

In order to connect the instrument to a PC you must connect the Optical serial cable code C2001 shipped with the instrument to a PC COM port.

The available transmission speeds are the following:

9600, 19200, 57600 (default value)

The value of the transmission speed (Baud Rate) is displayed on the initial screen (immediately after turning on the instrument, see paragraph 4.2). The value of this parameter can be modified only with the management software.

**For download instructions please refer to software help file.**

In order to transfer the memorized data from the instrument to the PC the following procedure must be followed (after SW installation):

1. **Switch ON the instrument and wait that Initial screen disappears (the rotary Switch position is not important). Be sure instrument should be in any screen exception for "Z2Ω" screen which only used to activate serial connection with IMP57 optional accessory (see paragraph 6.4.1).**
2. **Connect the Optical serial output of the instrument to the serial output of the PC through the Original C2001 serial cable**
3. **Run the program**
4. **Select the "Download" command**
5. **Refer to software help ON Line for further instructions.**

## 13. CONNECTION THROUGH BLUETOOTH PROTOCOL



### WARNING

Such a connection requires a PC provided with Bluetooth protocol.

The instrument enables you to transfer the stored data in a "wireless" way (with typical parameters of Bluetooth protocol). Operate as follows:



1. Connect the instrument to remote unit (optional accessory **C2008**) using USB/optical cable C2006. Check LED "USB" turning on.
2. Select the speed of data transfer equal to **57600** baud using the arrow keys on C2008 (check that such a value is set on the instrument).
3. Effect the search for the C2008 device (for further details look up the C2008 user's manual) until the instrument identifies it.
4. Start the TopView software following the procedure (look up the on line help for further details) to start transfer of data.

## 14. MAINTENANCE

### 14.1. GENERAL INSTRUCTION

1. The tester you have purchased is a precision instrument. Strictly follow the instructions for use and storage reported in this manual to avoid any possible damage or danger during use.
2. Do not use this tester under unfavourable conditions of high temperature or humidity. Do not expose to direct sunlight.
3. Be sure to turn off the tester after use. If the instrument is not to be used for a long period you are recommended to remove batteries to avoid acid leakage which may damage the internal circuits of the instrument.

### 14.2. BATTERY REPLACEMENT

The symbol  shows the battery charge: If it is completely "black" the battery are full charge, while the  symbol indicate weak batteries. When the batteries are too low to execute the test the instrument will show a warning message.

In the case interrupt testing and replace batteries according the following the procedure. **The instrument is capable of keeping the data stored even though batteries are not installed. The Instrument Date and Time settings aren't lost if you change the batteries within 24hours.**

#### WARNING



Only skilled technicians can perform this operation. Before replacing batteries make sure that all test leads have been disconnected from input terminals. **The instrument holding recording dates also without internal batteries.**

1. Switch OFF the instrument.
2. Remove all the test leads from the input terminals.
3. Unscrew the fixing screws from the battery compartment cover and remove it.
4. Remove all batteries replacing them with 6 new ones of the same type (1.5V – LR6 – AA – AM3 – MN 1500) respecting the polarity signs.
5. Fix the screws on the battery compartment cover. Then put the holster on.

### 14.3. INSTRUMENT CLEANING

Use a soft dry cloth to clean the instrument. Never use wet cloths, solvents, water, etc.

### 14.4. END OF LIFE



**CAUTION:** this symbol indicates that equipment and its accessories shall be subject to a separate collection and correct disposal.

## 15. TECHNICAL SPECIFICATIONS

### 15.1. TECHNICAL FEATURES

Accuracy is indicated as [% of reading + number of digits]. It refers to the following atmospheric conditions: a temperature of  $23^{\circ}\text{C} \pm 5^{\circ}\text{C}$  with a relative humidity  $< 60\%$ .

#### 15.1.1. Safety Test functions

##### ● LOW $\Omega$ : 200mA CONTINUITY TEST (AUTO, RT+, RT- MODE)

Range [ $\Omega$ ]	Resolution [ $\Omega$ ]	Accuracy(*)
0.01 $\div$ 9.99	0.01	$\pm(2\% \text{ rdg} + 2 \text{ digit})$
10.0 $\div$ 99.9	0.1	

(\*) After Test leads calibration

Test Current  $> 200\text{mA DC per } R \leq 5\Omega$  (Test leads included)  
 Resolution for Test current: 1mA  
 Open Circuit Voltage  $4\text{V} \leq V_0 \leq 24\text{V}$

##### ● M $\Omega$ : INSULATION TEST

Test Voltage [V]	Range [ $M\Omega$ ]	Resolution [ $M\Omega$ ]	Accuracy
50	0.01 $\div$ 9.99	0.01	$\pm(2\% \text{ rdg} + 2 \text{ digit}) \text{ se } V/R > 1\mu\text{A}$
	10.0 $\div$ 49.9	0.1	
	50.0 $\div$ 99.9	0.1	
100	0.01 $\div$ 9.99	0.01	$\pm(2\% \text{ rdg} + 2 \text{ digit}) \text{ se } V/R > 1\mu\text{A}$
	10.0 $\div$ 99.9	0.1	
	100.0 $\div$ 199.9	0.1	
250	0.01 $\div$ 9.99	0.01	$\pm(2\% \text{ rdg} + 2 \text{ digit}) \text{ se } V/R > 1\mu\text{A}$
	10.0 $\div$ 199.9	0.1	
	200 $\div$ 249	1	
	250 $\div$ 499	1	
500	0.01 $\div$ 9.99	0.01	$\pm(2\% \text{ rdg} + 2 \text{ digit}) \text{ se } V/R > 1\mu\text{A}$
	10.0 $\div$ 199.9	0.1	
	200 $\div$ 499	1	
	500 $\div$ 999	1	
1000	0.01 $\div$ 9.99	0.01	$\pm(2\% \text{ rdg} + 2 \text{ digit}) \text{ se } V/R > 1\mu\text{A}$
	10.0 $\div$ 199.9	0.1	
	200 $\div$ 999	1	
	1000 $\div$ 1999	1	

Open circuit Test Voltage  $< 1.3 \times \text{Nominal Test Voltage}$   
 Short Circuit Current  $< 6.0\text{mA}$  with 500V Test Voltage  
 Nominal Test Current  $> 2.2\text{mA}$  with 230k $\Omega$  (at 500V)  
 $> 1\text{mA}$  with 1k $\Omega \times V_{\text{nom}}$  (other voltage test)  
 Set limit values: 0.05, 0.10, 0.23, 0.25, 0.50, 1.00, 100M $\Omega$

##### ● RCD: TEST ON RCD DEVICES

Nominal Test Current ( $I_{\Delta N}$ ) 10mA, 30mA, 100mA, 300mA, 500mA  
 RCD type AC, A General e Selective  
 Phase to Earth Test Voltage 100V  $\div$  265V 50 Hz  
 Frequency 50Hz  $\pm$  0.5Hz

- Tripping Time Measurement  $t_{\Delta N}$

Range [ms]	Resolution [ms]	Accuracy
$\frac{1}{2} I_{\Delta N}, I_{\Delta N}$ 1 $\div$ 999	1	$\pm(2\% \text{ rdg} + 2\text{digit})$
2 $I_{\Delta N}$ 1 $\div$ 200 general		
1 $\div$ 250 selective		
5 $I_{\Delta N}$ RCD 1 $\div$ 50 general 1 $\div$ 160 selective		

- Contact Voltage  $U_t$

Range [V]	Resolution [V]	Accuracy
$0 \div 2U_{t\text{lim}}$	0.1	- 0%, +(5% rdg + 3digit)

$U_t$  LIM (UL): 25V o 50V

- Global Earth Resistance Measurement (avoiding RCD tripping)

Range [ $\Omega$ ]	Resolution [ $\Omega$ ]	Accuracy $I_{\Delta N}$
1 $\div$ 1999	1	- 0%, +(5% rdg + 3digit)

Test Current 0.5  $I_{\Delta N}$  set  
15mA in Ra 15mA

- Tripping Current Measurement

$I_{\Delta N}$	RCD Type	Range $I_{\Delta N}$ [mA]	Portata $I_{\Delta N}$ [mA]	Resolution [mA]	Accuracy $I_{\Delta N}$
$I_{\Delta N} \leq 10\text{mA}$	AC	$(0.5 \div 1.4) I_{\Delta N}$	$(0.5 \div 1.4) I_{\Delta N}$	0.1 $I_{\Delta N}$	- 0%, +10% $I_{\Delta N}$
	A	$(0.5 \div 2.4) I_{\Delta N}$		0.1 $I_{\Delta N}$	- 0%, +10% $I_{\Delta N}$
$I_{\Delta N} > 10\text{mA}$	AC	$(0.5 \div 1.4) I_{\Delta N}$	$(0.5 \div 1.4) I_{\Delta N}$	0.1 $I_{\Delta N}$	- 0%, +10% $I_{\Delta N}$
	A	$(0.5 \div 2) I_{\Delta N}$		0.1 $I_{\Delta N}$	- 0%, +10% $I_{\Delta N}$

**FREQUENCY MEASUREMENT**

Range [Hz]	Resolution [Hz]	Accuracy
47.0 ÷ 63.6	0.1	±(0.1%rdg + 1 digit)

RCD and LOOP function are active only for 50Hz ± 0,5Hz frequency

**VOLTAGE MEASUREMENT (RCD, LOOP, PHASE ROTATION)**

Range [V]	Resolution [V]	Accuracy
30 ÷ 460V	1	±(3%rdg + 2digit)

**LOOP P-P, P-N: LINE IMPEDANCE MEASUREMENT (Phase – Phase, Phase - Neutral)**

Range [Ω]	Resolution [Ω]*	Accuracy
0.01 ÷ 9.99	0.01	±(5% rdg + 3digit)
10.0 ÷ 199.9	0.1	

(\*) 0.1 mΩ on range 0.0 ÷ 199.9 mΩ (with IMP57)

Peak value of the Test current

127V 3.65A

230V 6.64A

400V 11.5A

Voltage Range (Phase – Phase, Phase – Neutral) 100÷265/100÷440V 50Hz

Frequency 50Hz ± 0.5Hz

**LOOP P-PE: FAULT LOOP IMPEDANCE MEASUREMENT (Phase - Earth)**

Range [Ω]	Resolution [Ω]*	Accuracy
0.01 ÷ 19.99	0.01	±(5%rdg + 3digit)
20.0 ÷ 199.9	0.1	
200 ÷ 1999	1	

(\*) 0.1 mΩ on range 0.0 ÷ 199.9 mΩ (with IMP57)

Peak value of the Test current:

127V 3.65A

230V 6.64A

Voltage Range (Phase –Earth)

100÷265V 50Hz

Frequency

50Hz ± 0.5Hz

**LOOP R<sub>a</sub> 15mA: FAULT LOOP IMPEDANCE MEASUREMENT without RCD Tripping (Phase - Earth)**

Range [Ω]	Resolution [Ω]	Accuracy
1 ÷ 1999	1	- 0%, +(5%rdg + 3digit)

Test Current

15mA

Voltage Range (Phase –Earth)

100÷265V 50Hz

Frequency

50Hz ± 0.5Hz

**EARTH: GROUND RESISTANCE MEASUREMENT WITH EARTH RODS**

Range RE [Ω]	Resolution [Ω]	Accuracy
0.01 – 19.99	0.01	±(5% rdg + 3 digit)
20.0 – 199.9	0.1	
200 – 1999	1	

Test Current

<10mA – 77.5Hz

Open circuit Test Voltage

<20V RMS

**RESISTIVITY MEASUREMENT**

Range ρ	Resolution	Accuracy
0.60 ÷ 19.99 Ωm	0.01 Ωm	±(5% rdg + 3 digit)
20.0 ÷ 199.9 Ωm	0.1 Ωm	
200 ÷ 1999 Ωm	1 Ωm	
2.00 ÷ 99.99 kΩm	0.01 kΩm	
100.0 ÷ 125.6 kΩm(*)	0.1 kΩm	

(\*) setting distance = 10m

Range of rods distance

d: 1±10m

Test Current

<10mA – 77.5Hz

Open circuit Test Voltage

<20V RMS

**CONTINUITY TEST WITH 10A**

Range [Ω]	Resolution [Ω]	Accuracy
0.001 ÷ 0.999	0.001	±(1% rdg + 2 digit)

Test current

> 10A AC if R ≤ 0.45Ω

Test Current Resolution :

0.1A

Open circuit Test Voltage

6 < V<sub>o</sub> < 12V~

Power Supply

230V ~ 50Hz

**CONTINUITY TEST WITH 10A**

Range [V]	Resolution [V]	Accuracy
0.01 ÷ 9.99	0.01	±(1% rdg + 2 digit)

Test current

> 10A AC if R ≤ 0.45Ω

Test Current Resolution :

0.1A

Open circuit Test Voltage

Less than 12V~

Power Supply

230V~ 50Hz



## 15.1.2. ANALYSER and AUX functions

### ● VOLTAGE AC/DC MEASUREMENT– SINGLE PHASE AND THREE PHASE SYSTEM (AUTORANGE)

Range [V]	Resolution [V]	Accuracy	Input Impedance
15 ÷ 310V	0.2V	±(0.5%rdg +2digit)	300kΩ (Phase-Neutral) 300kΩ (Phase - Phase)
310 ÷ 600V	0.4V		

For DC voltage add 0.5%rdg to tolerance. AC frequency 45 .. 65Hz.

### ● AC VOLTAGE SAG AND SURGE DETECTION – SINGLE PHASE AND THREE PHASE SYSTEM (MANUAL RANGE)

Range [V]	Resolution (Voltage)	Resolution (Time)	Accuracy (Voltage)	Accuracy (rif. 50Hz) (Time)	Input Impedance
15 ÷ 310V	0.2V	10ms	±(1.0%rdg +2digit)	± 10ms	300kΩ(Phase -Neutral) 300kΩ (Phase - Phase)
30 ÷ 600V	0.4V				

AC frequency 45 .. 65Hz.

### ● AC CURRENT MEASUREMENT for FlexEXT and STD clamps–SINGLE PHASE AND THREE PHASE SYSTEM (AUTORANGE)

Range [V] (*)	Resolution [mV]	Accuracy	Input Impedance	Overload Protection
0.005÷0.26V	0.1	±(0.5%rdg +2digit)	200kΩ (GSC57)	5V
0.26÷1V	0.4		400kΩ (GSC53N and ZG47)	

(\*): Example: with a 1000A/1V full scale clamp , the instrument detect only current higher than 5A, AC frequency 45 .. 65Hz.

### ● AC CURRENT MEASUREMENT with FlexINT clamps (GSC53N and ZG47) - 1000A range

Range (A)	Voltage input	Resolution	Accuracy
10.0 ÷ 19.9	950.0μV ÷ 1.691mV	8.5μV	±(4.0% rdg + 8.5μV)
20.0 ÷ 99.9	1.7mV ÷ 8.491mV		±(1.0% rdg + 8.5μV)
100.0 ÷ 999.9	8.5mV ÷ 84.99mV		±(1.0% rdg + 85μV)

1A = 85μV ; Rinput = 400kΩ, AC frequency 45 .. 65Hz

### ● AC CURRENT MEASUREMENT with FlexINT clamps (GSC53N and ZG47) - 3000A range

Range (A)	Voltage input	Resolution	Accuracy
30.0 ÷ 999.9	2.55mV ÷ 84.99mV	8.5μV	±(1.0%rdg + 17μV)
1000 ÷ 3000	85.0mV ÷ 255mV	85μV	±(0.5% rdg + 85μV)

1A = 85μV ; Rinput = 400kΩ, AC frequency 45 .. 65Hz

### ● AC POWER MEASUREMENT – SINGLE PHASE AND THREE PHASE SYSTEM (AUTORANGE)

Quantity	Range	Accuracy	Resolution
ACTIVE POWER	100.0 ÷ 999.9W	±(1.0%rdg+2digit)	0.1W
	1.000 ÷ 9.999kW		0.001kW
	10.00 ÷ 99.99kW		0.01kW
	100.0 ÷ 999.9kW		0.1kW
	1.000 ÷ 9.999MW		0.001MW
	10.00 ÷ 99.99MW		0.01MW
	100.0 ÷ 999.9MW		0.1MW
REACTIVE POWER	100.0 ÷ 999.9VAR		0.1VAR
	1.000 ÷ 9.999kVAR		0.001kVAR
	10.00 ÷ 99.99kVAR		0.01kVAR
	100.0 ÷ 999.9kVAR		0.1kVAR
	1.000 ÷ 9.999MVAR		0.001MVAR
	10.00 ÷ 99.99MVAR		0.01MVAR
	100.0 ÷ 999.9MVAR		0.1MVAR
APPARENT POWER	100.0 ÷ 999.9VA	0.1VA	
	1.000 ÷ 9.999kVA	0.001kVA	
	10.00 ÷ 99.99kVA	0.01kVA	
	100.0 ÷ 999.9kVA	0.1kVA	
	1.000 ÷ 9.999MVA	0.001MVA	
	10.00 ÷ 99.99MVA	0.01MVA	
	100.0 ÷ 999.9MVA	0.1MVA	
ACTIVE ENERGY	100.0 ÷ 999.9Wh	0.1Wh	
	1.000 ÷ 9.999kWh	0.001kWh	
	10.00 ÷ 99.99kWh	0.01kWh	
	100.0 ÷ 999.9kWh	0.1kWh	
	1.000 ÷ 9.999MWh	0.001MWh	
	10.00 ÷ 99.99MWh	0.01MWh	
	100.0 ÷ 999.9MWh	0.1MWh	
REACTIVE ENERGY	100.0 ÷ 999.9VARh	0.1VARh	
	1.000 ÷ 9.999kVARh	0.001kVARh	
	10.00 ÷ 99.99kVARh	0.01kVARh	
	100.0 ÷ 999.9kVARh	0.1kVARh	
	1.000 ÷ 9.999MVARh	0.001MVARh	
	10.00 ÷ 99.99MVARh	0.01MVARh	
	100.0 ÷ 999.9MVARh	0.1MVARh	

Accuracy grant for V> 100V, I > 10%FS, cos φ > 0.5, AC frequency 45 .. 65Hz

**● Cos φ MEASUREMENT – SINGLE PHASE AND THREE PHASE SYSTEM**

Cos φ	Resolution	Accuracy [°]
0.20 ÷ 0.50	0.01	1.0
0.50 ÷ 0.80		0.7
0.80 ÷ 1.00		0.6

AC frequency 45 .. 65Hz

**● VOLTAGE AND CURRENT HARMONICS MEASUREMENT – SINGLE PHASE AND THREE PHASE SYSTEM**

Range	Accuracy	Resolution
DC – 25H	±(5% rdg + 2 digit)	0.1V / 0.1A
26H – 33H	±(10% rdg + 2 digit)	
34H – 49H	±(15% rdg + 2 digit)	

Harmonics values are null under fixed threshold:

- DC: its values is null if it is &lt; 2% of Fundamental or is &lt; 2% of Full Scale clamp

 - 1<sup>st</sup> Current Harmonic: its values is null if it is < 0.2% Full Scale clamp

 - 2<sup>nd</sup> ÷ 49<sup>th</sup>: its values is null if it is < 2% of fundamental or is < 2% of Full Scale clamp

AC frequency 45 .. 65Hz, FLEX settings disabled DC component measurement,

**● ENVIRONMENTAL PARAMETER MEASUREMENT (AUX function)**

Parameter	Range	Accuracy	Resolution
TEMPERATURE	-20°C ÷ 80 °C	±(2%rdg + 2dgt)	0.1 °C
HUMIDITY	0 ÷ 100% HR		0.1% UR
ILLUMINATION	0.001Lux ÷ 20.00 Lux (*)		0.001 ÷ 0.02 Lux
	0.1Lux ÷ 2000 Lux (*)		0.1 ÷ 2 Lux
	1Lux ÷ 20 kLux (*)		1 ÷ 20 Lux

(\*) Accuracy for luxmetric probe is compliance with AA class

**● LEAKAGE CURRENT MEASUREMENT**

Range (*)	Resolution [mA]	Accuracy	Input Impedance	Overload Protection
0.5 ÷ 999.9mA	0.1mA	±(5%rdg + 2dgt)	200kΩ	5V

 (\*) During a recording the instrument detect only Current > 5mA with Resolution 1mA, AC frequency 45 .. 65Hz  
 The maximum recording value is the peak value calculated with 1ms response time

## 15.2. STANDARDS

### 15.2.1. General

Safety:	EN 61010-1
Protection classification:	Double Insulation
Pollution degree:	2
Protection Degree:	IP50
Overvoltage Category:	CAT III 300V~ (Phase–Earth)/CAT II 350V~ (phase–Earth) Input max 600V~ between inputs.
Usage:	Indoor; max height 2000m

### 15.2.2. EMC

This instrument was designed in compliance with the EMS standards in force and its compatibility was tested relatively to EN61326-1.

**This instrument complies with the requirements of the European Low Voltage Directive 2006/95/CE (LVD) and EMC Directive 2004/108/CE**

### 15.2.3. Safety Test

LOWΩ (200mA):	IEC 61557-4
MΩ:	IEC 61557-2
RCD:	IEC 61557-6
LOOP P-P, P-N, P-PE:	IEC 61557-3
PHASE SEQUENCE:	IEC 61557-7
EARTH:	IEC 61557-5
LOWΩ 10A:	EN60439-1, EN60204-1

### 15.2.4. ANALYSER

Voltage Sag and Surge:	EN50160
Alternating Current Static Watt-hour meters for Active Energy:	EN61036 (CLASS 2)
Alternating Current Static VAR-hour meters for Reactive Energy:	IEC1268 (CLASS 3)

## 15.3. GENERAL SPECIFICATIONS

### 15.3.1. Mechanical Data

Dimensions: 225 (L) x 165 (W) x 105 (H)mm  
Weight: 1,2Kg approx

### 15.3.2. Power supply

Batteries: 6 x 1.5-LR6-AA-AM3-MN 1500  
Battery Life: LOW $\Omega$ : approx: 800 test  
M $\Omega$ : approx: 500 test  
RCD AC and A Type: approx: 1000 test  
LOOP P-P, P-N, P-PE: approx: 1000 test  
Ra $\perp$ : approx: 1000 test  
EARTH: approx: 1000 test  
LOW $\Omega$ 10A: approx: 1000 test  
PHASE SEQUENCE: approx: 1000 test  
AUX (recording): approx: 20 Hours  
ANALYSER (recording): approx: 20 Hours  
Code A0050 (only for ANALYSER and AUX function, optional for GSC57)

External Power Supply Adapter: 230VAC – 50Hz (only for LOW $\Omega$ 10A)

Voltage supply: 230VAC – 50Hz (only for LOW $\Omega$ 10A)

### 15.3.3. Display

Display Type: Graphic with Backlight  
Resolution: 128x128  
Visible Area: 73mm x 73mm

### 15.3.4. Memory

Safety Test Memory: 999 measurement  
ANALYSER: 2MByte (with 63 channels select and Integration Period = 15min ->more than 30 days).

## 15.4. ENVIRONMENT

Reference Temperature: 23° ± 5°C  
Working Temperature Range: 0° ÷ 40°C  
Working Humidity: < 80%  
Storage Humidity Range: -10 ÷ 60°C  
Storage Humidity: < 80%

## 15.5. ACCESSORIES

### GSC57 - Standard accessories

#### Description

- Cable with 3 terminals with shuko plug
- Set with 4 cables (2m), 4 crocodiles, 2 test leads
- Set with 4 cables and 4 earth rods
- Power Supply cable for LOW $\Omega$ 10A function
- Management Software
- Optical-USB Cable
- Carrying Case
- Calibration Certificate
- Instruction Manual

#### Code

C2033X  
KITGSC5  
KITERRNE  
C5700  
TOPVIEW  
C2006  
BORSA2051  
ISO9000

### GSC57 - Optional Accessories

#### Description

- External Power Supply Adapter for Recordings
- 4 cable (twisted) 5m with crocodiles for 10A continuity test.
- 4 cable (twisted) 10m with crocodiles for 10A continuity test.
- Set for carrying Belt
- Temperature and Humidity Probe
- Multirange Illuminance Probe 20-2000-20000Lux/2V
- Kit of 3 flexible clamps 300-3000A/1V diameter 174 mm
- AC Current clamp 200-2000A/1V – cable 2m
- AC Current clamp 3000A/1V – cable 2m
- Leakage AC Current clamp 1-100-1000A/1V diameter 54 mm
- AC Current clamp 10-100-1000A/1V diameter 54 mm
- Box for connection with TA 3x1-5A/1V
- Accessory for Loop Impedance measure at high resolution

#### Code

A0050  
C7000/05  
C7000/10  
CN0050  
HT52/05  
HT53/05  
HTFLEX3003  
HP30C2  
HP30C3  
HT96U  
HT97U  
HT903  
IMP57

**GSC53N and ZG47 - Standard accessories****Description**

- Cable with 3 terminals with shuko plug
- Set with 4 cables (2m), 4 crocodiles, 2 test leads
- Set with 4 cables and 4 earth rods
- External Power Supply Adapter for Recordings
- Kit of 3 flexible clamp 1000/3000A – Diameter 174mm
- Management Software
- Optical USB Cable
- Carrying Case
- Calibration Certificate
- Instruction Manual

**Code**

C2033X  
KITGSC5  
KITERRNE  
A0050  
HTFLEX33  
TOPVIEW  
C2006  
BORSA2051  
ISO9000

**GSC53N and ZG47 - Optional Accessories****Description**

- Set for carrying Belt
- Temperature and Humidity Probe
- Multirange Illuminance Probe 20-2000-20000Lux/2V
- AC Current clamp 200-2000A/1V – cable 2m
- AC Current clamp 3000A/1V – cable 2m
- Leakage AC Current clamp 1-100-1000A/1V diameter 54 mm
- AC Current clamp 10-100-1000A/ 1V diameter 54 mm
- Box for connection with TA 3x1-5A/1V
- Accessory for Loop Impedance measure at high resolution

**Code**

CN0050  
HT52/05  
HT53/05  
HP30C2  
HP30C3  
HT96U  
HT97U  
HT903  
IMP57

## 16. SERVICE

### 16.1. WARRANTY CONDITIONS

This instrument is guaranteed against any defect in material and manufacturing in compliance with the general sales terms and conditions. Throughout the period of guarantee all defective parts may be replaced and the manufacturer reserves the right to repair or replace the product.

If the instrument is to be returned to the after-sales service or to a dealer transportation costs are on the customer's behalf. Shipment shall be however agreed upon.

A report must always be enclosed to a rejected product stating the reasons of its return.

To ship the instrument use only the original packaging material; any damage that may be due to no-original packing shall be charged to the customer.

The manufacturer declines any responsibility for damages caused to persons and/or objects.

Warranty is not applied in the following cases:

- ☞ Any repair that might be necessary as a consequence of a misuse of the instrument or of its use with no compatible devices.
- ☞ Any repair that might be necessary as a consequence of improper packaging.
- ☞ Any repair that might be necessary as a consequence of service actions carried out by unauthorised personnel.
- ☞ Any modification of the instrument carried out without the authorisation of the manufacturer.
- ☞ Use not provided for in the instrument's specifications or in the instruction manual.

The content of this manual cannot be reproduced in any form whatsoever without prior authorisation of the manufacturer.

**NOTE**      **All our products are patented and their trade marks registered. The manufacturer reserves the right to modify the product specifications and prices if this is aimed at technological improvements**

### 16.2. SERVICE

If the instrument does not operate properly, before contacting the after-sales service check cables as well as test leads and replace them if necessary.

Should the instrument still operate improperly check that the operation procedure is correct and conforms with the instructions given in this manual.

If the instrument is to be returned to the after-sales service or to a dealer transportation costs are on the customer's behalf. Shipment shall be however agreed upon.

A report must always be enclosed to a rejected product stating the reasons of its return.

To ship the instrument use only the original packaging material; any damage that may be due to no-original packing shall be charged to the customer.

## 17. PRACTICAL REPORTS FOR ELECTRICAL TESTS

### 17.1. Continuity Test on Protective Conductors

#### PURPOSE OF THE TEST

- Check the continuity of:
- ☞ protective conductors (PE), main equalising potential conductors (EQP), secondary equalising potential conductors (EQS) in TT and TN-S systems.
  - ☞ neutral conductors having functions of protective conductors (PEN) in TN-C system.

**NOTE:** This test is to be preceded by a visual check verifying the existence of yellow-green protective and equalising potential conductors as well as compliance of the sections used with the standards' requirements.

#### INSTALLATION PARTS TO BE CHECKED

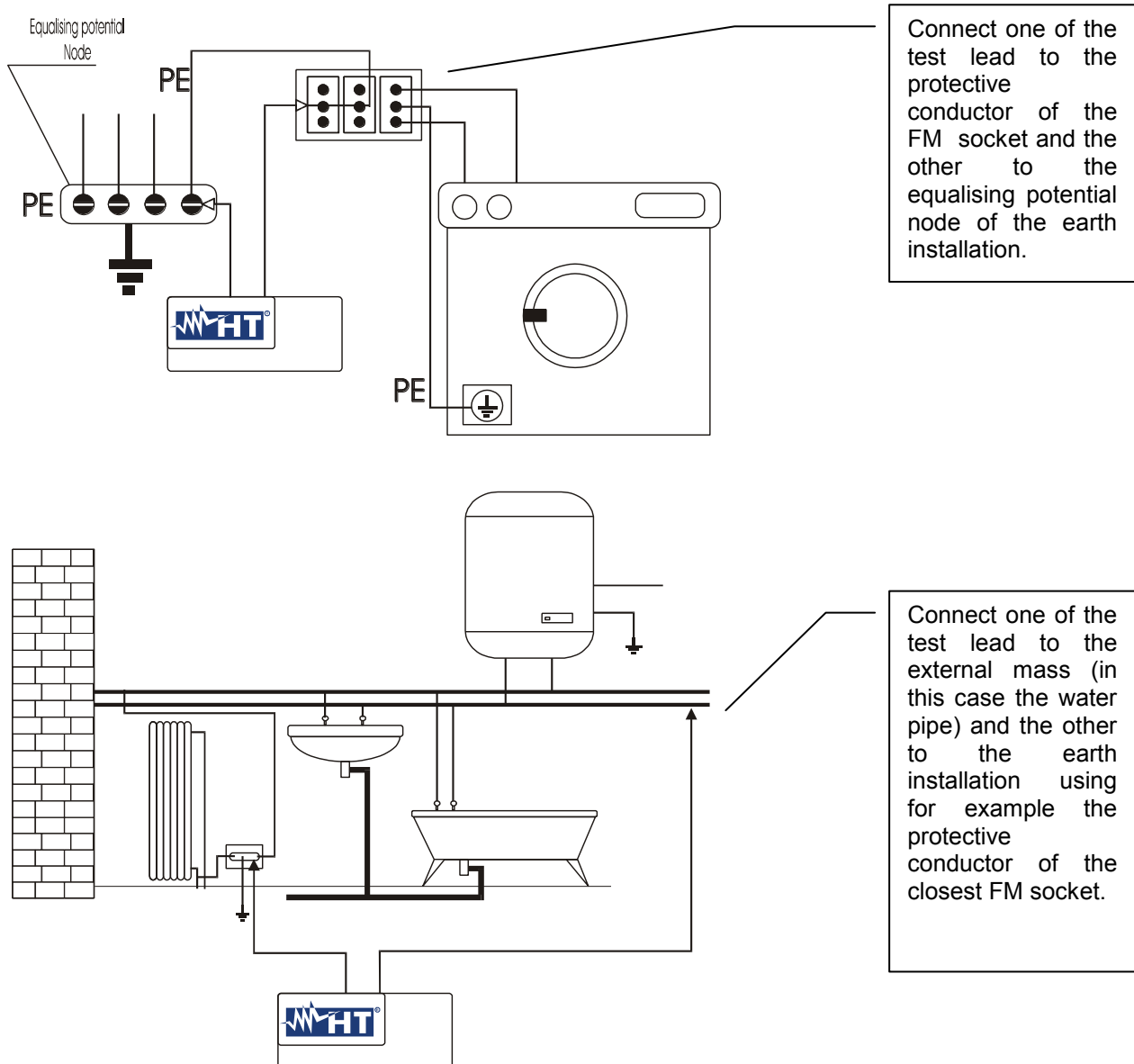

**Examples for continuity measurement on conductors**

**Check the continuity among:**

- a) earth poles of **all** the plugs and earth collector or node.
- b) earth terminals of class I instruments (Boiler etc.) and earth collector or node.
- c) main external masses (water, gas pipes etc.) and earth collector or node.
- d) auxiliary external masses to the earth terminal.

**ALLOWABLE VALUES**

The IEE 16<sup>th</sup> edition standards do not give any indication on the maximum resistance values which cannot be overcome, in order to be able to declare the positive outcome of the continuity test.

The standard IEE 16<sup>th</sup> edition simply requires that the instrument in use warns the operator if the test was not carried out with a **current of at least 0.2 A** and an **open circuit voltage ranging from 4 V to 24 V**.

The resistance values can be calculated according to the sections and lengths of the conductors under test, anyway if the instrument detects values of some ohm the test can be considered as passed.



## 17.2. Insulation Resistance Measurement of The Electrical Installations (250Vdc, 500Vdc, 1000Vdc)

### EXAMPLE OF INSULATION MEASUREMENT ON AN INSTALLATION

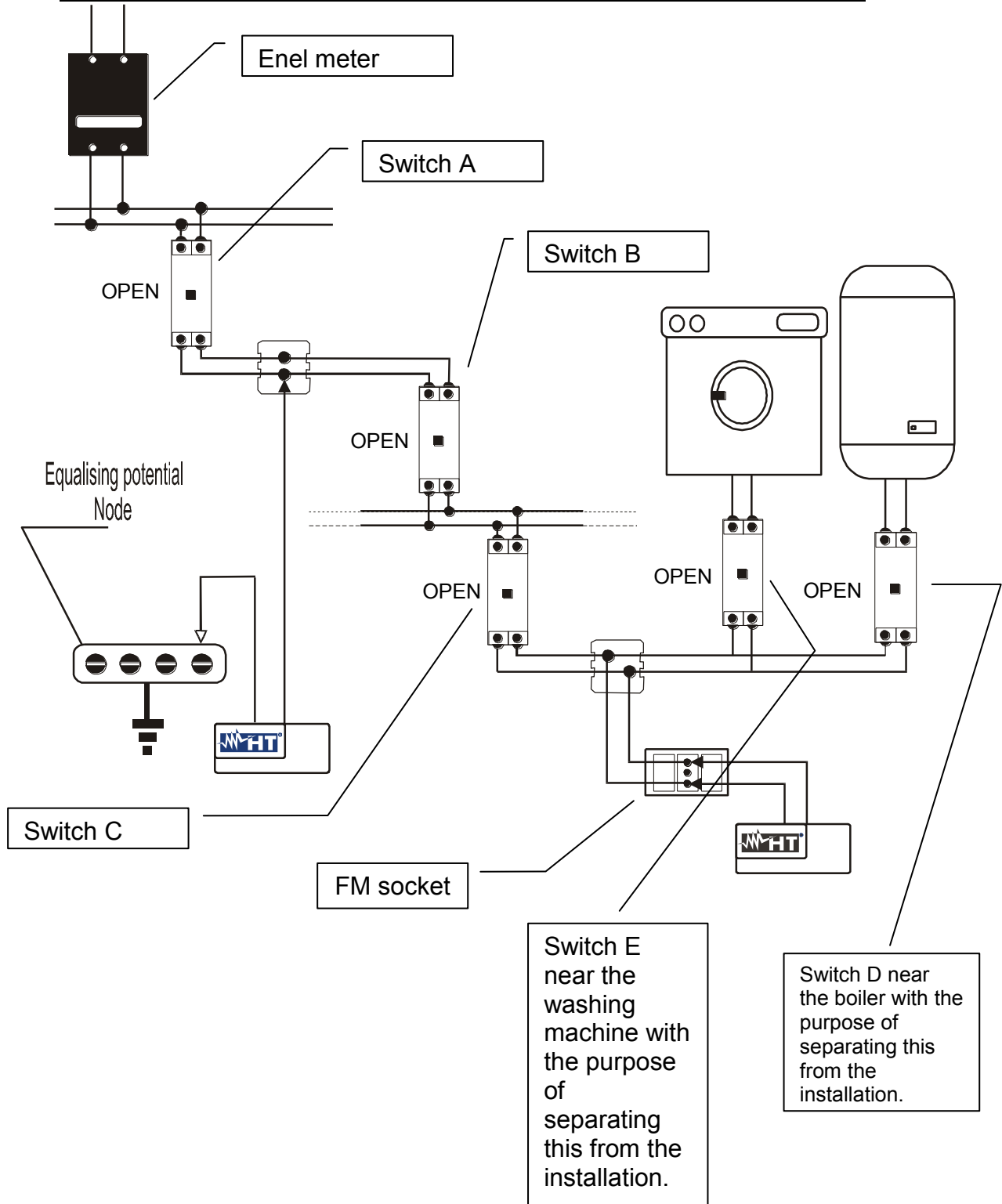

**Insulation measurements on an installation.**

## PURPOSE OF THE TEST

Check that the insulation resistance of the installation complies with the requirements of IEE 16<sup>th</sup> edition standard.

**NOTA:** This test is to be effected on an open circuit with any load disconnected.

### ☞ INSTALLATION PARTS TO BE CHECKED

- a) Between each active conductor and the earth (the neutral conductor is considered an active conductor except in the case of TN-C systems where it is considered part of the earth (PEN).

During this measurement all active conductors can be connected to each other, in case the measurement result does not fall within the standard limits the test is to be repeated for each single conductor.

- b) Among active conductors.

The IEE 16<sup>th</sup> edition standard recommends to check the insulation among the active conductors when this is possible (ATTENTION).

A procedure indicating how to effect the insulation resistance measurement on an installation is reported in the following table:

### Procedure for insulation resistance measurement referred to the previous picture:

Switch situation		Point under test	Measurement result	Judgement on the installation
1	Turn the switch A, I D and E off	Effect the measurement on switch A	$Se R \geq R_{LIMITE}$	☺ OK (end of the test)
			$Se R < R_{LIMITE}$	Proceed ☞ 2
2	Turn the switch B off	Effect the measurement on switch A	$Se R \geq R_{LIMITE}$	Proceed ☞ 3
			$Se R < R_{LIMITE}$	⊗ INSTALLATION NOT COMPLYING WITH STANDARDS
3		Effect the measurement on switch B	$Se R \geq R_{LIMITE}$	☺ OK (end of the test)
			$Se R < R_{LIMITE}$	Proceed ☞ 4
4	Turn the switch C off	Effect the measurement on switch B	$Se R \geq R_{LIMITE}$	Proceed ☞ 5
			$Se R < R_{LIMITE}$	⊗ INSTALLATION NOT COMPLYING WITH STANDARDS
5		Effect the measurement on switch C	$Se R \geq R_{LIMITE}$	☺ OK (end of the test)
			$Se R < R_{LIMITE}$	⊗ INSTALLATION NOT COMPLYING WITH STANDARDS

Table7: table with procedure steps for insulation measurement referred to the installation reported in Insulation measurements on an installation.

**Note** The switches D and E are those installed near the load having the purpose of separating it from the installation. In case the above said RCDs do not exist it is necessary to disconnect the users from the installation before effecting the insulation resistance test.

## WARNING



If the installation includes electronic devices, disconnect them from the installation and in case this is impossible only the test "a" is to be effected, that is to say between active conductors (which in this case SHALL be connected together) and the earth.

## ALLOWABLE VALUES

Rated circuit voltage (V)	Test voltage (V)	Insulation resistance (MΩ)
SELV and PELV*	250	≥0.250
Up to 500 V included, except for the above circuits.	500	≥0.500
Over 500 V	1000	≥1.000
* In the new standards the terms SELV and PELV replace the old definitions "safety low voltage" or "functional".		

Table8: table summarising a few example of the test voltage values and relative limit values.

### NOTE:

- ☞ If the circuit is quite large the conductors running side by side make up a capacity which is to be charged by the instrument in order to carry out a correct measurement; in this case it is recommended to keep the **GO** key pressed (in case a test is effected under manual mode) until the result gets stable.
- ☞ The indication "> 1999MΩ" or "o.r." (out of range) warns that the insulation resistance measured by the instrument is higher than the maximum resistance limit (see technical specifications); this result is obviously far higher than the minimum limits of the above table therefore if during a test this symbol is displayed the insulation of that point is to be considered in compliance with standards.

### WARNING



When you effect measurements among active conductors it is essential to disconnect all the users (alarm lamps, intercom transformers, boilers etc) otherwise the instrument will measure their resistance instead of the installation insulation. Moreover any insulation resistance test among active conductors could damage them.

### 17.3. Check of the Circuit Separation

#### PURPOSE OF THE TEST

The test, to be effected in case the protection is realised through separation (SELV or PELV or electrical separation), shall check that the insulation resistance measured according to the indications below (depending on the separation type) complies with the limits reported in the table relative to the insulation measurements.

#### ☞ INSTALLATIONPARTS TO BE CHECKED

- **SELV** system (Safety Extra Low Voltage):
  - ✓ measure the resistance between the active parts of the circuit under test (separate) and the active parts of the other circuits.
  - ✓ measure the resistance between the active parts of the circuit under test (separate) and the earth.
  
- **PELV** system (Protective Extra Low Voltage):
  - ✓ measure the resistance between the active parts of the circuit under test (separate) and the active parts of the other circuits.
  
- **Electrical separation:**
  - ✓ measure the resistance between the active parts of the circuit under test (separate) and the active parts of the other circuits.
  - ✓ measure the resistance between the active parts of the circuit under test (separate) and the earth.

**EXAMPLE OF CHECKING THE SEPARATION AMONG ELECTRICAL CIRCUITS**

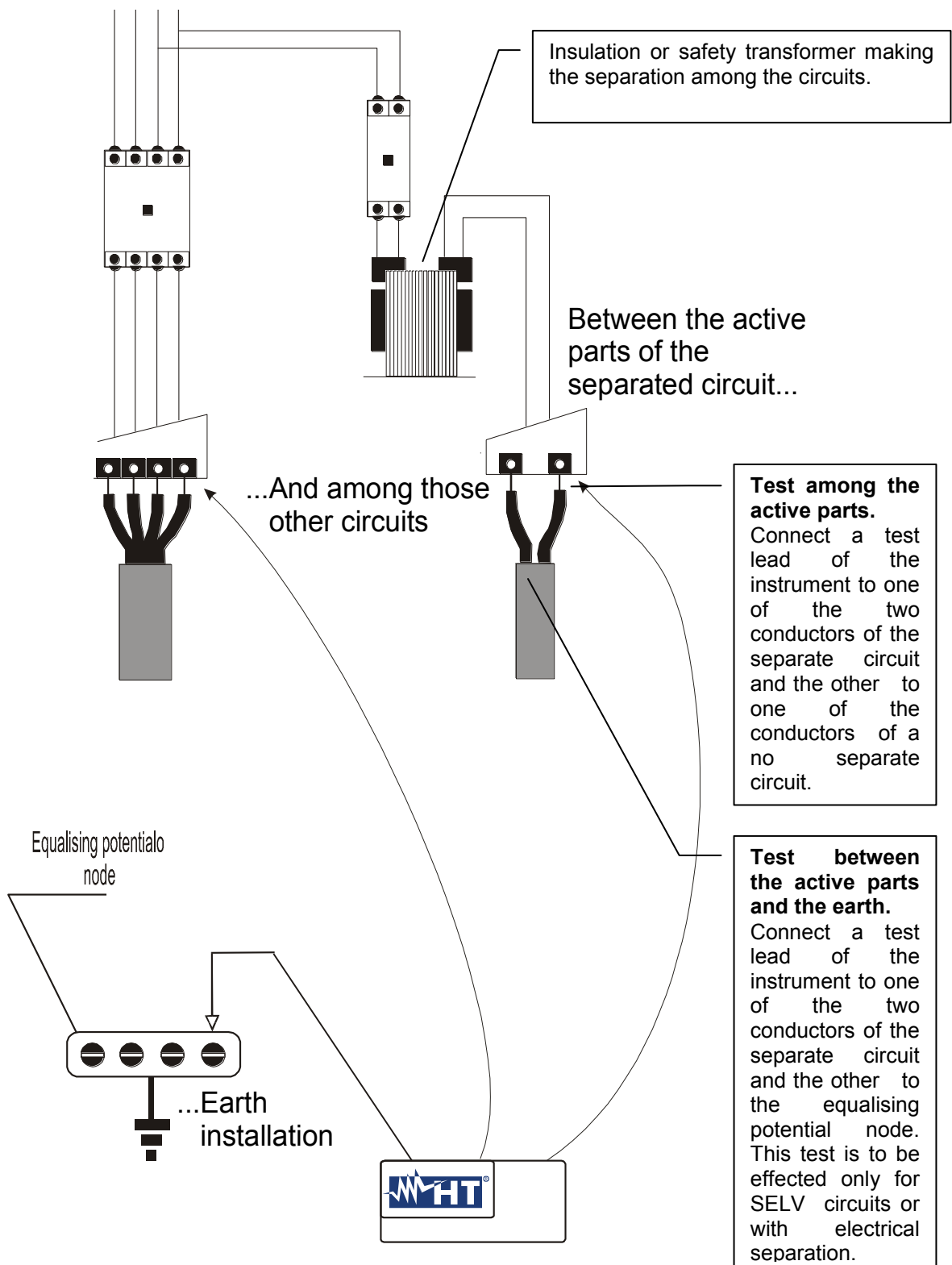

**Measurement of separation among the installation circuits**

## ALLOWABLE VALUES

The test result is positive when the insulation resistance indicates values higher or equal to those indicated in the table reported in the section relative to insulation tests.

### Notes:

- **SELV** system: is a system of category zero or very low safety voltage featured by:
  - ✓ Power supply: autonomous source (ex. batteries, small generator) or safety (ex. safety transformer).
  - ✓ Protection separation to other electrical systems (double or reinforced insulation or a metal screen connected to the earth).
  - ✓ There are no earthed points (insulated from the earth).
  
- **PELV** system: is a system of category zero or very low safety voltage featured by:
  - ✓ Power supply: autonomous source (ex. batteries, small generator) or safety (ex. safety transformer).
  - ✓ Protection separation to other electrical systems (double or reinforced insulation or a metal screen connected to the earth).
  - ✓ There are earthed points (not insulated from the earth).
  
- **Electrical separation**: is a system featured by:
  - ✓ Power supply: insulation transformer or autonomous source with equivalent features (ex. generator).
  - ✓ Protection separation to other electrical systems (insulation not lower than that of the insulation transformer).
  - ✓ Protection separation to the earth (insulation not lower than that of the insulation transformer).

## 17.4. Earth Resistance Measurement in TT Systems

### PURPOSE OF THE TEST

Check that the RCD is co-ordinated with the earth resistance value. It is not possible to assume an earth resistance value as reference limit when controlling the test result, while it is necessary to check every time that the co-ordination complies with the requirements of the standards.

### ☞ INSTALLATION PARTS TO BE CHECKED

The earth installation under working conditions. The check is to be effected without disconnecting the earth plates.

### ALLOWABLE VALUES

The earth resistance value measured shall meet the following relation:

$$R_A < 50 / I_a$$

where:  $R_A$  = Resistance of the earth installation, the value can be set with the following measurements:

- Earth resistance with three-wire volt-ampere method.
- Fault loop impedance (see (\*))
- Two-wire earth resistance (see (\*\*))
- Two-wire earth resistance in the socket (see (\*\*))
- Earth resistance obtained by the measurement of contact voltage  $U_t$  (see (\*\*)).
- Earth resistance obtained by the tripping time test of the RCDs (A, AC), RCDs S (A, AC) (see (\*\*)).

$I_a$  = Tripping current in 5s of the RCD; rated tripping current of the RCD (in the case of RCD S 2  $I_{\Delta n}$ ).

50 = Safety limit voltage (reduced down to 25V in special rooms).

(\*) If the installation is protected by an RCD the measurement shall be effected upstream or downstream the RCD short circuiting it to avoid its tripping.

(\*\*) These methods, even though not provided by the standards IEE 16<sup>th</sup> edition provide values resulted to be indicative of the earth resistance .

### ☞ **EXAMPLE FOR EARTH RESISTANCE TEST**

Let's assume an installation protected by a 30 mA RCD. Let's measure the earth resistance using one of the methods quoted above, to evaluate whether the installation resistance is complying with the standards in force and multiply the result by 0.03A (30 mA). If the result is lower than 50V (or 25V for special rooms) the installation can be considered as co-ordinated as it respects the above-said relation.

When we face 30 mA RCDs (the most of civil installations) the maximum earth resistance allowed is  $50/0.03=1666\Omega$  permitting to use even simplified methods which even though they do not provide extremely precise values give a value approximate enough for the calculation of the co-ordination.

## 17.5. Working Test of Rcds (Rcd, Rcd/Dc, Rcd S, Rcd/Dc S)

### **PURPOSE OF THE TEST**

Check whether general and selective RCDs have been installed and adjusted properly and whether they maintain their features over the time.

The check shall confirm that the RCD trips at a current  $I_{\Delta}$  lower than its rated working current  $I_{\Delta n}$  and that the tripping time meets, depending on the case, the following conditions:

- does not exceed the maximum time provided by the standards in case of RCDs of general type (according to Table 3).
- is included between the minimum tripping time and the maximum one in case of RCDs of selective type (according to Table 3).

The RCD test effected by means of the test key is aimed at preventing "**the gluing effect**" from compromising the working of the RCD which has been inactive for a long time; therefore this test is effected only to verify the mechanical working of the RCD and it does not permit to declare that the RCD is complying with the standards. According to a statistical survey the periodical check, once a month, of the RCDs by means of the test key reduces by one half the RCD fault rate, this test however detects only 24% of defective RCDs.

### ☞ **INSTALLATION PARTS TO BE CHECKED**

All the RCDs shall be tested when installed.

In the low voltage installations the test is recommended to grant an acceptable safety level.

For the medical rooms this check shall be effected periodically every six months on all RCDs.

**Note** In case the earth installation is not available effect the test connecting the instrument with one terminal on a conductor downstream the RCD and one terminal on the other conductor upstream the RCD itself.



## ALLOWABLE VALUES

To compare the measurements make reference to the Table 3 reporting the limits for the tripping times. On each RCD it is necessary to effect: a test with leakage current in phase with voltage and a leakage current phase shifted by 180° with respect to the voltage. The highest time is to be considered as significant result.

The test at  $\frac{1}{2}I_{\Delta n}$  SHALL NEVER cause the RCD tripping.

### NOTE:

- Before effecting the test at the RCD rated current the instrument carries out a test at  $\frac{1}{2}I_{\Delta n}$  to measure the contact voltage and the overall earth resistance; if during this test the RCD trips the indication I "rcd" is displayed. During this test the RCD may trip for three possible reasons:
  - a) The RCD tripping current is lower than  $\frac{1}{2}I_{\Delta n}$ .
  - b) An earth plate is already present on the installation which added to the earth generated by the instrument causes the RCD tripping.
  - c) There is no earth installation.
- If during measurement of contact voltage the voltage detected is higher than the safety value (50V or 25V) the test is interrupted; proceeding with the test under such conditions would mean to keep the contact voltage applied to all the metal masses connected to the earth for a too long time resulting to be dangerous.
- Among the test results of the RCD tripping time also the earth resistance value  $R_a$  is displayed in  $\Omega$ , this value for the TN and IT systems is not to be considered while for the TT systems it is merely indicative.

## 17.6. Test of Rcd Tripping Time (Rcd, Rcd/Dc)

### PURPOSE OF THE TEST

Check the real tripping time of the general RCDs (it does not apply to the selective RCDs).

### 🔧 INSTALLATION PARTS TO BE CHECKED

When facing RCDs with tripping current to be selected it is useful to effect this test to check the real RCD tripping current. For RCDs with fixed differential current this test can be effected to detect any leakage of the installation users.

In case the earth installation is not available effect the test connecting one instrument 's terminal on a conductor downstream the RCD and one terminal on the other conductor upstream the RCD itself.

### ALLOWABLE VALUES

The tripping current shall range from  $\frac{1}{2}I_{\Delta n}$  to  $I_{\Delta n}$ .

### NOTE:

- Make reference to the notes of the previous chapter.
- To check whether significant leakage currents are present on the installation operate as follows:
  - a) After deactivating all the loads effect the tripping current measurement and take note of the value.
  - b) Activate the loads and effect a new measurement of the tripping current; if the RCD trips with a lower current, the installation leakage is the difference between the two tripping currents. If during the test "rcd" is displayed the installation leakage current added to the current for contact voltage measurement ( $\frac{1}{2}I_{\Delta n}$ ) causes the RCD tripping.

## 17.7. Measurement of Short-Circuit Fault Impedance ( $Z_{pn}$ , $Z_{pp}$ )

### PURPOSE OF THE TEST

Check that the tripping power of the RCD is higher than the maximum fault current of the installation.

#### ☛ INSTALLATION PARTS TO BE CHECKED

The test shall be effected in the point where the short circuit current is the highest possible, usually immediately downstream the RCD to be checked.

The test shall be effected between phase and phase ( $Z_{pp}$ ) in the three phase installations and between phase and neutral ( $Z_{pn}$ ) in the single-phase installations..

### ALLOWABLE VALUES

Three-phase installations:

$$P_i > \frac{400}{Z_{pp}} * \frac{2}{\sqrt{3}}$$

Single-phase installations:

$$P_i > \frac{230}{Z_{pn}}$$

dove:  $P_i$  = tripping power of the RCD

$Z_{pp}$  = impedance measured between phase and phase.

$Z_{pn}$  = impedance measured between phase and neutral

## 17.8. Fault Loop Impedance Measurement (Phase – Earth)

### PURPOSE OF THE TEST

The fault loop is the circuit of the current when there is a bad isolation of the electrical system toward earth. The fault loop is composed:

- Transformer coil impedance.
- The impedance of the line from the transformer to the fault.
- The impedance of the protective conductor from the conductive part to the neutral of the transformer.

When the instrument measure the impedance of the fault loop, the instrument detect the prospective phase-PE short-circuit current so the operator can determine if magnetothermal protection is coordinated to the protection of indirect contacts.

### WARNING



The resolution of the instrument is 10mΩ when the impedance value is inside (0.01 – 19.99) Ω, so use the instrument for measurements of impedance higher of 100mΩ. For measurements on installations with short circuit currents over 230kA use the instrument together **IMP57** optional accessory.

#### ☛ POINTS TO BE CHECKED

The test is necessary in TN or IT electrical system without RCDS.

### ALLOWED VALUES

The following relation has to be fulfil:

$$Z_s \leq U_o / I_a$$

dove:  $U_o$  = Phase-Earth Voltage.

$Z_s$  = Impedance Phase-Earth.

$I_a$  = tripping current of the magnetothermal protection in 5 seconds.

## 17.9. Earth Resistivity Measurement

### PURPOSE OF THE TEST

This test aims at analysing the resistivity value of the ground in order to define the type of rods to be used.

### EQUIPMENT PARTS TO BE TESTED

For the resistivity test admissible values do not exist. The various values measured by positioning the rods at growing distances "a" must be quoted in a graph. According to the resulting curve, suitable rods will be chosen. As the test result can be affected by metal parts buried (such as pipes, cables or other rods), in case of doubts take a second measurement positioning the rods at an equal distance "a", but rotating their axis by 90°.

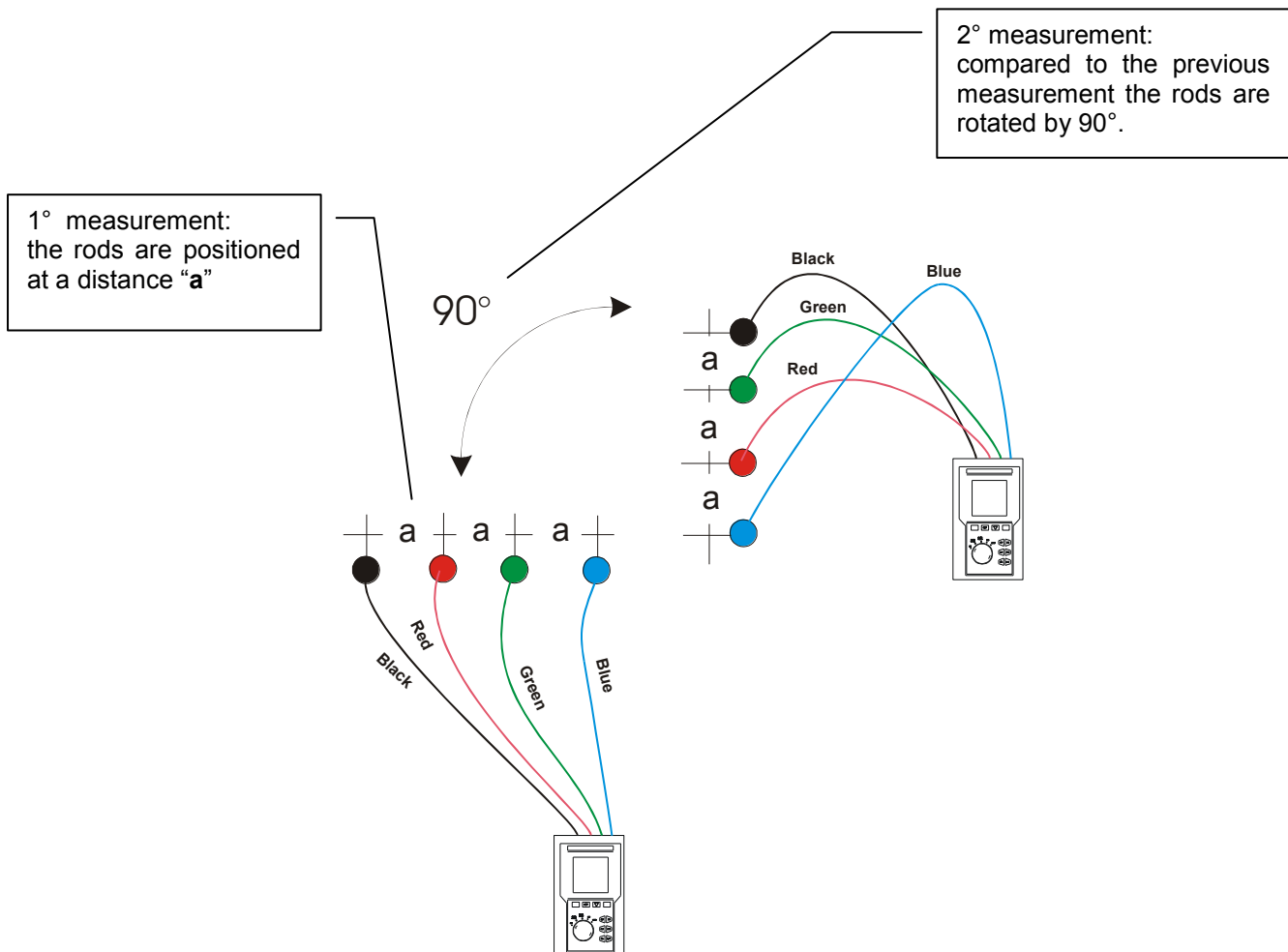

The resistivity value is calculated with the following formula:

$$\rho = 2\pi aR$$

where:  $\rho$  = specific resistivity of the ground  
 $a$  = distance between the rods (m)  
 $R$  = resistance measured by the instrument ( $\Omega$ )

The measuring method allows to define the specific resistance up to the depth corresponding approximately to the distance "a" between the rods. If you increase the distance "a" you can reach deeper ground layers and check the ground homogeneity. After several  $\rho$  measurements, at growing distances "a", you can trace a profile like the following ones, according to which the most suitable rod is chosen:

**Curve1:** as  $\rho$  decreases only in depth, it's possible to use only a rod in depth.

**Curve2:** as  $\rho$  decreases only until the depth A, it's not useful to increase the depth of the rod beyond A.

**Curve3:** even at a superior depth,  $\rho$  does not decrease, therefore a ring rod must be used.

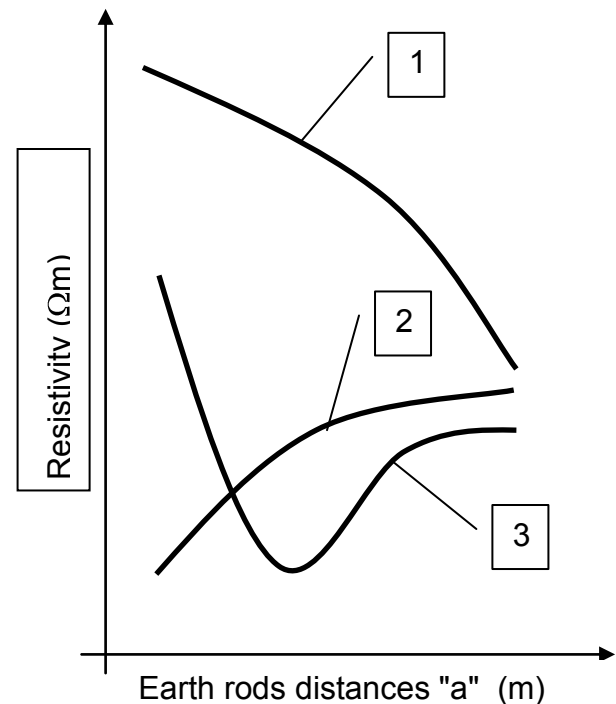

## APPROXIMATE EVALUATION OF THE CONTRIBUTION OF INTENTIONAL RODS

The resistance of a rod  $R_d$  can be calculated with the following formulas ( $\rho$  = medium resistivity of the ground).

a) resistance of a vertical rod

$$R_d = \rho / L$$

L= length of the element touching the ground

b) resistance of an horizontal rod

$$R_d = 2\rho / L$$

L= length of the element touching the ground

c) resistance of linked elements

The resistance of a complex system with more elements in parallel is always higher than the resistance which could result from a simple calculation of elements in parallel, especially if those elements are close and therefore interactive. For this reason, in case of a linked system the following formula is quicker and more effective than the calculation of the single horizontal and vertical elements:

$$R_d = \rho / 4r$$

r= radius of the circle which circumscribes the link.

## 17.10. VOLTAGE ANOMALIES (VOLTAGE SAG AND SURGE)

The instruments are able to record as voltage anomalies all those rms values, calculated every 10ms, beyond the percent thresholds of Voltage Reference (Vref) set during the programming from 3% to 30 % (with step of 1%).

The Reference must be set to:

Nominal Voltage Phase to Neutral: for Single Phase and 4 wires three phase system

Nominal Voltage Phase to Phase: for 3 wires three phase system

Example1: Three Phase System 3 wires.

Vref = 400V, LIM+= 6%, LIM-=10% =>

High Lim = 400 x (1+6/100) = 424,0V

Low Lim = 400 x (1-10/100) = 360

Example2: Three Phase System 4 wires.

Vref = 230V, LIM+= 6%, LIM-=10% =>

High Lim = 230 x (1+6/100) = 243,08V

Low Lim = 230 x (1-10/100) = 207,0V

The Instrument will detect Voltage Anomalies if the RMS Voltage Values (calculated every 10ms) beyond the above calculated thresholds. These limits remain unchanged throughout the recording period.

When a Voltage anomaly occurs the instrument records:

- The number corresponding to the phase where the anomaly occurred.
- The “direction” of the anomaly: “UP” and “DN” identify respectively voltage drops (sag) and peaks (Surge).
- The date and time of the beginning of the event in the form day, month, year, hour, minutes, seconds, hundredths of second.
- The duration of the event, in seconds with a resolution of 10ms.
- The minimum (or maximum) value of voltage during the event.

## 17.11. VOLTAGE AND CURRENT HARMONICS

### 17.11.1. Theory

Any periodical non-sine wave can be represented as a sum of sinusoidal waves having each a frequency that corresponds to an entire multiple of the fundamental, according to the relation:

$$v(t) = V_0 + \sum_{k=1}^{\infty} V_k \sin(\omega_k t + \varphi_k) \quad (1)$$

where:

$V_0$  = Average value of  $v(t)$

$V_1$  = Amplitude of the fundamental of  $v(t)$

$V_k$  = Amplitude of the  $k^{\text{th}}$  harmonic of  $v(t)$

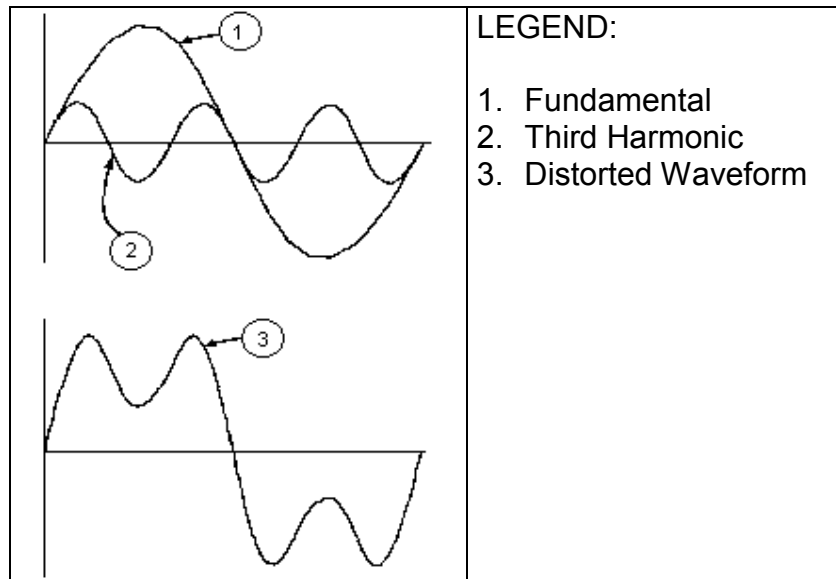

### Effect of the sum of 2 multiple frequencies.

In the mains voltage, the fundamental has a frequency of 50 Hz, the second harmonic has a frequency of 100 Hz, the third harmonic has a frequency of 150 Hz and so on. Harmonic distortion is a constant problem and should not be confused with short events such as sags, surges or fluctuations.

It can be noted that in (1) the index of the sigma is from 1 to the infinite. What happens in reality is that a signal does not have an unlimited number of harmonics: a number always exists after which the harmonics value is negligible. The EN 50160 standard recommends to stop the index in the expression (1) in correspondence of the 40<sup>th</sup> harmonic.

A fundamental element to detect the presence of harmonics is THD defined as:

$$THD_v = \frac{\sqrt{\sum_{h=2}^{\infty} V_h^2}}{V_1}$$

This index takes all the harmonics into account. The higher it is, the more distorted the waveform gets.

### 17.11.2. Limit values for harmonics

EN50160 standard fixes the limits for the harmonic voltages, which can be introduced into the network by the power supplier. In normal conditions, during whatever period of a week, 95% of the RMS value of each harmonic voltage, mediated on 10 minutes, will have to be inferior than or equal to the values stated in the following table.

The total harmonic distortion (THD) of the supply voltage (including all the harmonics up to 40<sup>th</sup> order) must be inferior than or equal to 8%.

Odd harmonics				Even harmonics	
Not multiple of 3		Multiple of 3		Order h	Relative voltage %Max
Order h	Relative voltage % Max	Order h	Relative voltage % Max		
5	6	3	5	2	2
7	5	9	1,5	4	1
11	3,5	15	0,5	6..24	0,5
13	3	21	0,5		
17	2				
19	1,5				
23	1,5				
25	1,5				

These limits, theoretically applicable only for the supplier of electric energy, provide however a series of reference values within which the harmonics introduced into the network by the users must be contained.

### 17.11.3. Presence of harmonics: causes

Any apparatus that alters the sine wave or uses only a part of such a wave causes distortions to the sine wave and therefore harmonics.

All current signals result in some way virtually distorted. The most common situation is the harmonic distortion caused by non-linear loads such as electric household appliances, personal computers or speed control units for motors. Harmonic distortion causes significant currents at frequencies that are odd multiples of the fundamental frequency. Harmonic currents affect considerably the neutral wire of electric installations.

In most countries, the mains power is three-phase 50/60Hz with a delta primary and star secondary transformers. The secondary generally provides 230V AC from phase to neutral and 400V AC from phase to phase. Balancing the loads on each phase has always represented an headache for electric systems designers.

Until some ten years ago, in a well balanced system, the vectorial sum of the currents in the neutral was zero or quite low (given the difficulty of obtaining a perfect balance). The devices were incandescent lights, small motors and other devices that presented linear loads. The result was an essentially sinusoidal current in each phase and a low current on the neutral at a frequency of 50/60Hz.

“Modern” devices such as TV sets, fluorescent lights, video machines and microwave ovens normally draw current for only a fraction of each cycle thus causing non-linear loads and subsequent non-linear currents. All this generates odd harmonics of the 50/60Hz line frequency. For this reason, the current in the transformers of the distribution boxes contains only a 50Hz (or 60Hz) component but also a 150Hz (or 180Hz) component, a 50Hz (or 300Hz) component and other significant components of harmonic up to 750Hz (or 900Hz) and higher.

The vectorial sum of the currents in a well balanced system that feeds non-linear loads may still be quite low. However, the sum does not eliminate all current harmonics. The odd multiples of the third harmonic (called “TRIPLENS”) are added together in the neutral and can cause overheating even with balanced loads.

#### 17.11.4. Presence of harmonics: consequences

In general, even harmonics, i.e. the 2<sup>nd</sup>, 4<sup>th</sup> etc., do not cause problems. Triple harmonics, odd multiples of three, are added on the neutral (instead of cancelling each other) thus creating a condition of overheating of the wire which is extremely dangerous.

Designers should take into consideration the three issues given below when designing a power distribution system that will contain harmonic current:

- The neutral wire must be of sufficient gauge.
- The distribution transformer must have an additional cooling system to continue operating at its rated capacity when not suited to the harmonics. This is necessary because the harmonic current in the neutral wire of the secondary circuit circulates in the delta-connected primary circuit. This circulating harmonic current heats up the transformer.
- Phase harmonic currents are reflected on the primary circuit and continue back to the power source. This can cause distortion of the voltage wave so that any power factor correction capacitors on the line can be easily overloaded.

The 5<sup>th</sup> and the 11<sup>th</sup> harmonic contrast the current flow through the motors making its operation harder and shortening their average life.

In general, the higher the ordinal harmonic number, the smaller its energy is and therefore the impact it will have on the devices (except for transformers).

#### 17.12. POWER AND POWER FACTOR DEFINITION

In a standard electric installation powered by three sine voltages the following is defined:

Phase Active Power: (n=1,2,3)	$P_n = V_{nN} \cdot I_n \cdot \cos(\varphi_n)$
Phase Apparent Power: (n=1,2,3)	$S_n = V_{nN} \cdot I_n$
Phase Reactive Power: (n=1,2,3)	$Q_n = \sqrt{S_n^2 - P_n^2}$
Phase Power Factor: (n=1,2,3)	$P_{Fn} = \frac{P_n}{S_n}$
Total Active Power:	$P_{TOT} = P_1 + P_2 + P_3$
Total Reactive Power:	$Q_{TOT} = Q_1 + Q_2 + Q_3$
Total Apparent Power:	$S_{TOT} = \sqrt{P_{TOT}^2 + Q_{TOT}^2}$
Total Power Factor:	$P_{FTOT} = \frac{P_{TOT}}{S_{TOT}}$

where:

$V_{nN}$  = RMS value of voltage between phase n and Neutral.

$I_n$  = RMS value of n phase current.

$\varphi_n$  = Phase displacement angle between voltage and current of n phase.



In presence of distorted voltages and currents the previous relations vary as follows:

Phase Active Power: (n=1,2,3)	$P_n = \sum_{k=1}^{\infty} V_{kn} I_{kn} \cos(\varphi_{kn})$
Phase Apparent Power: (n=1,2,3)	$S_n = V_{nN} \cdot I_n$
Phase Reactive Power: (n=1,2,3)	$Q_n = \sqrt{S_n^2 - P_n^2}$
Phase Power Factor: (n=1,2,3)	$P_{F_n} = \frac{P_n}{S_n}$
Distorted Power Factor (n=1,2,3)	dPF <sub>n</sub> =cos φ <sub>1n</sub> = phase displacement between the fundamentals of voltage and current of n phase
Total Active Power:	$P_{TOT} = P_1 + P_2 + P_3$
Total Reactive Power:	$Q_{TOT} = Q_1 + Q_2 + Q_3$
Total Apparent Power:	$S_{TOT} = \sqrt{P_{TOT}^2 + Q_{TOT}^2}$
Total Power Factor:	$P_{F_{TOT}} = \frac{P_{TOT}}{S_{TOT}}$

where:

$V_{kn}$  = RMS value of kth voltage harmonic between n phase and Neutral.

$I_{kn}$  = RMS value of kth current harmonic of n phase.

$\varphi_{kn}$  = Phase displacement angle between kth voltage harmonic and kth current harmonic of n phase.

### **Note:**

It is to be noted that the expression of the phase Reactive Power with non sine waveforms, would be wrong. To understand this, it may be useful to consider that both the presence of harmonics and the presence of reactive power produce, among other effects, an increase of line power losses due to the increased current RMS value. With the above given relation the increasing of power losses due to harmonics is added to that introduced by the presence of reactive power. In effect, even if the two phenomena contribute together to the increase of power losses in line, it is not true in general that these causes of the power losses are in phase between each other and therefore that can be added one to the other mathematically.

The above given relation is justified by the relative simplicity of calculation of the same and by the relative discrepancy between the value obtained using this relation and the true value.

It is to be noted moreover, how in case of an electric installation with harmonics, another parameter called distorted Power Factor (dPF) is defined. In practice, this parameter represents the theoretical limit value that can be reached for Power Factor if all the harmonics could be eliminated from the electric installation.

### 17.12.1. Conventions on powers and power factors

As for the recognition of the type of reactive power, of the type of power factor and of the direction of the active power, the below conventions must be applied. The stated angles are those of phase-displacement of the current compared to the voltage (for example, in the first panel the current is in advance from  $0^\circ$  to  $90^\circ$  compared to the voltage):

<b>Equipment under test = Inductive Generator</b> ←		<b>90°</b>	<b>→ Equipment under test = Capacitive Load</b>	
	$P+ = 0$	$P- = P$	$P+ = P$	$P- = 0$
	$Pfc+ = -1$	$Pfc- = -1$	$Pfc+ = Pf$	$Pfc- = -1$
	$Pfi+ = -1$	$Pfi- = Pf$	$Pfi+ = -1$	$Pfi- = -1$
	$Qc+ = 0$	$Qc- = 0$	$Qc+ = Q$	$Qc- = 0$
	$Qi+ = 0$	$Qi- = Q$	$Qi+ = 0$	$Qi- = 0$
<b>180°</b>			<b>0°</b>	
	$P+ = 0$	$P- = P$	$P+ = P$	$P- = 0$
	$Pfc+ = -1$	$Pfc- = Pf$	$Pfc+ = -1$	$Pfc- = -1$
	$Pfi+ = -1$	$Pfi- = -1$	$Pfi+ = Pf$	$Pfi- = -1$
	$Qc+ = 0$	$Qc- = Q$	$Qc+ = 0$	$Qc- = 0$
	$Qi+ = 0$	$Qi- = 0$	$Qi+ = Q$	$Qi- = 0$
<b>Equipment under test = Capacitive Generator</b> ←		<b>270°</b>	<b>→ Equipment under test = Inductive Load</b>	

where:

Symbol	Significance	Remarks
P+	Value of the active power +	Positive parameter (user)
Pfc+	Capacitive power factor +	
Pfi+	Inductive power factor +	
Qc+	Value of the capacitive reactive power +	
Qi+	Value of the inductive reactive power +	
P-	Value of the active power -	Negative parameter (generator)
Pfc-	Capacitive power factor -	
Pfi-	Inductive power factor -	
Qc-	Value of the capacitive reactive power -	
Qi-	Value of the inductive reactive power -	

Value	Significance
P	The active power (positive or negative) is defined in the panel and therefore acquires the value of the active power in that moment.
Q	The reactive power (inductive or capacitive, positive or negative) is defined in the panel and therefore acquires the value of the reactive power in that moment.
Pf	The power factor (inductive or capacitive, positive or negative) is defined in the panel and therefore acquires the value of the power factor in that moment.
0	The active power (positive or negative) or the reactive power (inductive or capacitive, positive or negative) is NOT defined in the panel and therefore acquires a null value.
-1	The power factor (inductive or capacitive, positive or negative) is NOT defined in the panel.

### 17.12.2. 3 Phase 3 Wire System

In the electrical systems distributed without neutral, the phase voltages and the power factors and phase  $\cos\varphi$  lose importance. Only the phase to phase voltages, the phase currents and the total powers remain defined.

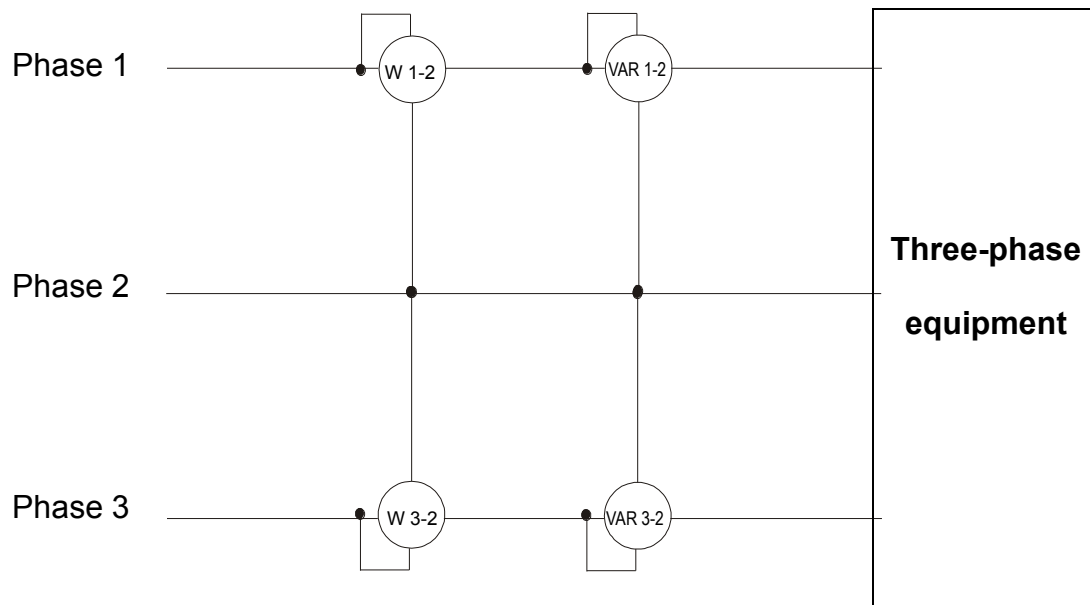

In this case the potential of one of the three phases (for example, phase 2) is taken on as reference potential. The total values of the active, reactive and apparent power are expressed as sum of the indications of the couples of Wattmeters, VARmeters and VAmeters.

$$P_{TOT} = W_{1-2} + W_{3-2}$$

$$Q_{TOT} = VAR_{1-2} + VAR_{3-2}$$

$$S_{TOT} = \sqrt{(W_{1-2} + W_{3-2})^2 + (VAR_{1-2} + VAR_{3-2})^2}$$

### 17.13. MEASURING METHOD: OUTLINES

The instrument is able to measure: voltages, currents, active powers, inductive and capacitive reactive powers, apparent powers, inductive and capacitive power factors, analogical or impulse parameters. All these parameters are analysed in a digital way: for each phase (voltage and current), 6 x 128 samples are acquired on a module of 16 x 20ms, repeated for the three phases.

#### 17.13.1. Integration periods

The storage of all the data would require a huge memory capacity.

Therefore we've tried to find out a storage method which permits to compress the information to be memorised, though providing significant data.

The chosen method is the integration one: after a certain period called "integration period", which can be set from 5 seconds to 60 minutes (3600sec), the instrument extracts from the sampled values the following values:

- Minimum value of the parameter during the integration period (harmonics excluded)
- Medium value of the parameter (intended as arithmetic average of all the values registered during the integration period)
- Maximum value of the parameter during the integration period (harmonics excluded)

Only this information (repeated for each parameter to be memorised) are saved in the memory along with starting time and date of the integration period.

Once these data are memorised, the instrument restarts to take measurements for a new period.

#### 17.13.2. Power factor calculations

According to the standards in force, the medium power factor can't be calculated as average of the instantaneous power factors. It must be obtained from the medium values of active and reactive power.

Each single medium power factor (of phase or total) is therefore calculated, at the end of each integration period, on the medium value of the corresponding powers independently on the fact that they must be registered or not.

Besides, for a better analysis of the type of load present on the line and in order to have terms of comparison when studying the invoicing of the low  $\cos\varphi$ , the values of inductive and capacitive  $\cos\varphi$  are treated as independent parameters.

## 18. APPENDIX 1 – MESSAGES DISPLAYED

MESSAGE	DESCRIPTION	ADVICES 
<b>AUTONOM:</b>	Available memory autonomy for the recording which is being effected	
<b>CLEAR ALL? (Enter)</b>	The operator is trying to cancel all the recordings effected	Press ESC in order not to cancel the whole memory, press ENTER to confirm
<b>CLEAR LAST? (Enter)</b>	The operator is trying to cancel the last recording effected	Press ESC in order not to cancel the last recording, press ENTER to confirm
<b>Data saved</b>	The data have been saved	
<b>DATA SIZE:</b>	Dimensions of the stored data	
<b>HOLD</b>	By pressing the proper key, the HOLD function has been activated	Press HOLD again to disable this function
<b>Password:</b>	A recording has been started and at least 5 minutes have passed from the last activity of the instrument (see paragraph 7).	Insert the password: <b>F1, F4, F3, F2</b>
<b>Invalid date</b>	The inserted date is not correct	Check the inserted date
<b>Energy Measuring</b>	The instrument is taking an energy measurement	Press F1 to stop it
<b>Memory Full</b>	The memory of the instrument is full	Cancel some recordings after transferring them to a PC
<b>No ext supply!</b>	A recording has been started without connecting the external power supply (code A0050; optional for GSC57)	Verify if you really want to start the recording without the external power supply. In that case press START again.
<b>No parameter sel</b>	A recording has been started without selecting any value to be recorded	Press START/STOP and select at least a value entering the MENU
<b>No Phase selected</b>	Voltage and/or current harmonics have been selected and the corresponding flag has been enabled (HARMONICS ON) but no phase voltage or current has been selected	Select at least one phase voltage and/or current
<b>PASSWORD ERROR</b>	The inserted password is wrong (see paragraph 7).	Check the password
<b>PASSWORD OK</b>	The inserted password is correct	
<b>Please wait</b>	The instrument is waiting for the recording to be started (see paragraph 6)	
<b>Recording</b>	The instrument is recording (see paragraph 6)	
<b>Too many param</b>	More than 63 parameters have been selected (harmonics included) or More than 38 parameters with CO-GENERATION Flag enabled	Deselect some values
<b>Too many records</b>	The quantity of recorded data + Smp exceeds the maximum allowed (35)	Cancel some recordings after transferring them to a PC
<b>No Unit selected</b>		
<b>ERR: SEQ</b>	The Phase Sequence isn't correct.	Check the Phase Sequence connection.
<b>ERR: P-</b>	The active powers shown on the right side of the message are negative	If there isn't a situation of co-generation check if the clamps are properly connected
<b>ERR: SEQ &amp; P-</b>	The active powers shown on the right side of the message are negative and the Phase Sequence isn't correct.	If there isn't a situation of co-generation check if the clamps are properly connected / check the Phase Sequence connection.
<b>ERR: CONNECTION</b>	The instrument has detected a wrong connection to Voltage inputs	Check the Voltage connections
<b>Error Vref</b>	The user set a Voltage reference not compatible with voltage at instrument's input.	Check Voltage Reference set in "CONFIG RECORDER"
<b>ERR: SYNC</b>	The System Frequency is out of range	Check the System Frequency, check setting in ANALYSER CONFIG.
<b>Selection Error</b>	There is a mismatch between the Parameter enabled and the parameter selected for an AUX recording.	Check the parameter enabled in AUX position and the selected parameter for recording.
<b>Error1 ÷ Error 5</b>	The instrument memory is damaged.	Contact HT Italia assistance

## 19. APPENDIX 2 – RECORDABLE PARAMETERS: SYMBOLS

Symbol	Description
V1, V2, V3	RMS value of the voltage of phase 1, phase 2, phase 3 respectively
V12, V23 V31	Value of phase to phase voltages
I1, I2, I3	RMS value of the current of phase 1, phase 2, phase 3 respectively
IN	RMS value of the current of the neutral
DC	Continuous component of voltage or current
h01 ÷ h49	Harmonic 01 ÷ Harmonic 49 of voltage or current
ThdV	Factor of total harmonic distortion of the voltage (see paragraph 17.11)
ThdI	Factor of total harmonic distortion of the current (see paragraph 17.11)

Pt, P1, P2, P3	Values of the total active power, of phase 1, phase 2, phase 3 respectively
P12, P32	(only for 3 wires measurement) Value of the power measured by the Wattmeter 1-2 and 3-2 respectively (see paragraph 17.12.2).
Qt, Q1, Q2, Q3	Values of the total reactive power, of phase 1, phase 2, phase 3 respectively
Q12, Q32	(only for 3 wires measurement) Value of the power measured by the VARmeter 1-2 and 3-2 respectively (see paragraph 17.12.2).
St, S1, S2, S3	Values of the total apparent power, of phase 1, phase 2, phase 3 respectively
S12, S32	(only for 3 wires measurement) Value of the power measured by the VAmeter 1-2 and 3-2 respectively (see paragraph 17.12.2).
Pft, pf1, pf2, pf3	Value of the total power factors, power factors of phase 1, phase 2, phase 3 respectively
dPft, dpf1, dpf2, dpf3	Values of the total $\cos\phi$ , of phase 1, phase 2, phase 3 respectively

Eat, Ea1, Ea2, Ea3	Values of the total active energy, of phase 1, phase 2, phase 3 respectively
Erit, Eri1, Eri2, Eri3	Values of the total inductive reactive Energy, of phase 1, phase 2, phase 3 respectively
Erct, Erc1, Erc2, Erc3	Values of the total capacitive reactive Energy, of phase 1, phase 2, phase 3 respectively





Via della Boaria 40  
48018 – Faenza (RA) - Italy  
Tel: +39-0546-621002 (4 linee r.a.)  
Fax: +39-0546-621144  
email: [ht@htitalia.it](mailto:ht@htitalia.it)  
<http://www.ht-instruments.com>