



**GLOSSARY**

- Lifetime Warranty .....	145
- Calibration Certification .....	145
- Certificate of Conformance .....	145
- VDE .....	145
- GS .....	145
- SANAS .....	145
- IEC .....	145
- True RMS (TRMS) .....	145
- Display Digits and Display Counts .....	145
- Counts .....	145
- Digits .....	145
- Accuracy .....	146
- Precision .....	146
- Resolution .....	146
- Range .....	146
- Measurement Categories or (CAT) Ratings .....	147
- Degree of Ingress Protection .....	147-148
- Cable Current Ratings .....	149
- Description of symbols .....	149
<b>INSTRUMENT INDEX</b> .....	150-151
<b>TOOLS INDEX</b> .....	151-154
Terms and Conditions of .....	155-156



## Lifetime Warranty LIFETIME WARRANTY

HellermannTyton carries a Lifetime Warranty on most tools and selected instruments. Instruments carry a 2 year limited warranty unless stated specifically to carry a lifetime warranty. If any product is found to be defective or faulty within this warranty, HellermannTyton will, at their sole discretion, repair or replace the affected product. This warranty does not cover batteries, fuses, or the neglect or misuse of products within abnormal conditions of operation, improper storage, damaged or altered as well as the wear of consumable products.

HellermannTyton products are warranted to be free from defects in material and workmanship at the time sold by us but our obligation under this warranty and that of the reseller is limited to the replacement of the product, and neither we nor the reseller are bound by any other warranty, expressed, implied or statutory.

Under no circumstances are we or the seller liable for any loss, damage, expenses or consequential or incidental damages of any kind arising out of the use or inability to use these products. All are sold with the understanding that the user will test them in actual use and determine their adaptability for the intended uses.

Please note that although the warranty covers most tools it does not cover all hydraulic and battery operated tools including gas solder irons where regular maintenance is required. Any software that may come with the tool or instrument does not fall under this warranty either. This warranty does not cover damages to products which are not installed, operated, used and maintained in accordance with disassembly or attempted disassembly by parties other than HellermannTyton or its authorised service representatives.

## Calibration Certification

Certifies that all the instrument's or tool's parameters are tested against its original specification

## Certificate of Conformance

The certificate is issued by the manufacturer stating that the instrument meets required specifications

## VDE

Verband der Elektrotechnik is a certification mark and attestation from one of Europe's largest technical and scientific associations for standardization of work and product testing.

Tools with double triangle are tested individually with a test Voltage of 10000V, highest degree of safety for working on live parts up to 1000V.

## GS

GS (Geprüfte Sicherheit) is a voluntary certification mark for technical equipment that has been tested and certified that it compliance with German and European safety requirements. The GS mark is based on the German Product Safety Act

## SANAS

South African National Accreditation System accreditation certificates are a formal recognition that an organisation is competent to perform specific tasks.

## IEC

International Electrotechnical Commission is the world's leading organisation for the preparation and publication of International Standards for all electrical, electronic and related technologies.

## True RMS (TRMS)

The normal alternating current mains power supply comprises a sinusoidal waveform that has symmetrical positive and negative half cycles. The RMS (Root Mean Square) value of an alternating current is measured in terms of the direct (dc) current that produces the same heating effect in the same resistance.

Problems arise when the mains waveform becomes distorted because of the effects of certain types of loads. This results in a non-sinusoidal waveform.

In order to get a True RMS measurement, we can measure the heat dissipated by a constant resistive load and perform the Power to Heat calculations. **(Power or Heat) = I<sup>2</sup> R** The result is a True RMS measurement. True-RMS (root mean square) instruments can measure alternating current (ac) or ac voltage with better accuracy.

## Display Digits and Display Counts

Display resolution on instruments is often specified in counts or digits.

The table, below is example of common resolution display conversion between digits and counts:

Count	Display Digit
2000	3½ (3.5)
4000	3¾ (3.75)
20000	4½ (4.5)

## Counts

Multimeters and testers use counts to display information. These instruments have various ranges used to obtain different values in measured readings. Counts indicate what can be displayed, before it changes to the next range, i.e. a multimeter with 5000 counts, changes to the next range when it reaches 50000 on its display.

**Example**, a meter with a 50000 count will read 49.999V on the display, but when it tries to display 50V, it will only read 050.00V, or simply 50.00V. Generally when the multimeter or clamp meter moves to the next range, one digit of resolution is lost.

## Digits

Alternatively, display resolution can be described in digits. As per the table above, when reading the digits, the whole number must be separated from the fraction.

**Example, a meter with 4.5 digits, or 4 and 1/2 digits needs to be read as follows:**

1. The "4" represents full digits - digits that can be represented or shown from 0-9 on the display
2. The "1/2", or "0.5" - is the first digit of the reading display as well as the maximum it can read i.e. "1/2" means the first digit that can represent the digit 0-1.

## Accuracy

An instrument's degree of reliability and degree of acceptable error can occur under specific operating conditions. Alternatively, how close the measurement is to the actual or reference value of the signal being measured.

Accuracy maybe represented as a percentage as well as digits.

Example: an accuracy of  $\pm 2\%$ , +2 digits means 100.0V reading on a multimeter can be from 97.8V to 102.2V.

Accuracy is generally compared to an accepted industry standard.

## Precision

An instrument's degree of repeatability i.e. how reliably can the instrument repeat the same measurement and read the exact same value when making a series of measurements.

Component aging, battery condition, temperature and warm-up time may all effect repeatability.

## Resolution

The smallest increment an instrument can detect and display such as hundredths, thousandths, millionths.

## Range

The upper and lower limits an instrument can measure a value or signal such as amps, volts and ohms.

The larger number of counts should translate into higher resolution and generally a higher accuracy.

## Safety Category or (CAT) Rating

Categories I-IV are used to rate a test instruments' ability to resist a voltage spike, which is applied through a specific resistance. Generally, a higher CAT rating, the safer the instrument.

### CAT IV (Primary supply level) – 3-Phase

Measurements performed at the source of low voltage installations

Application: electricity meters, primary overcurrent protection devices and ripple control units

### CAT III (Distribution level) – 3-Phase

Measurements performed in building installations

Application: distribution boards, circuit breakers, bus bars and junction boxes in fixed installations

### CAT II (Local level) – Single phase

Measurements performed on circuits directly connected to the low voltage installations

Application: household appliances, mobile devices and similar

### CAT I (Signal level) - Electronic

Measurement of electronic equipment not directly connected to mains

Application: Protected electronic devices

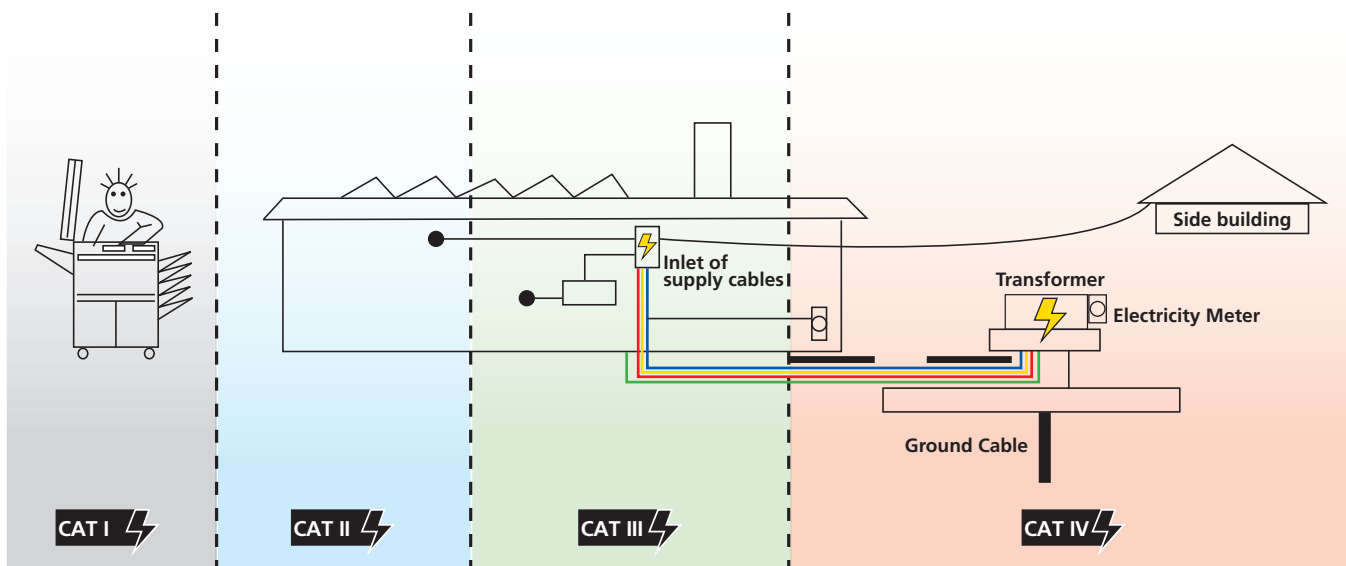

















A higher voltage rating within a category signifies a higher energy transient.

Example: CAT III-1000V instrument has superior protection compared to a CAT III-600V rated instrument.

## Degree of Ingress Protection (DIN EN IEC 60529)

Ingress Protection (IP) Rating (or International Protection Marking) of an instrument consists of the letters IP followed by two digits i.e. IP54. The two digits classify the degrees of protection provided against the intrusion of solid bodies including body parts like hands and fingers, dust, and accidental contact (first digit after IP), and water (second digit after IP) in electrical enclosures.

















1 <sup>st</sup> Digit: Solid Object Ingress		2 <sup>nd</sup> Digit: Water Ingress	
1 <sup>st</sup> Digit	Summary of Protection	2 <sup>nd</sup> Digit	Summary of Protection
0	 <b>No protection</b>	0	 <b>No protection</b>
1	 Protection against solid foreign bodies <b>&gt;50mm</b>	1	 Protection against <b>vertically dripping water</b>
2	 Protection against medium sized solid bodies <b>&gt;12.5mm</b>	2	 Protection against <b>vertically dripping water</b> when enclosure <b>tilted up to 15°</b>
3	 Protection against small solid bodies <b>&gt;2.5mm</b>	3	 Protection against <b>spraying water</b> (60° angle from any direction)
4	 Protection against granular solid bodies <b>&gt;1mm</b>	4	 Protection against <b>splashing water</b> from any direction
5	 Protection against limited ingress of dust	5	 Protection against <b>low pressure water jets</b>
6	 <b>Complete</b> protection against ingress of dust	6	 <b>Protection against strong jets of water</b>
		7	 <b>Protection during temporary immersion</b>
		8	 <b>Protection during continuous immersion</b>
		9k	 <b>Protection against high pressure/ stream jet cleaning</b>

## Cable Current Ratings

Conventional Rated Thermal Current (A)	Copper Conductor Section			
	Cable			
	No	Section (mm <sup>2</sup> )	Dia. (mm)	AWG
8	1	1	1.15	17
12	1	1.5	1.45	15
20	1	2.5	1.83	13
25	1	4.0	2.30	11
32	1	6.0	2.80	9
50	1	10	3.60	7
65	1	16	4.62	5
85	1	25	5.79	3
115	1	35	6.64	2
150	1	50	8.21	0 or 1/0
175	1	70	9.37	00 or 2/0
225	1	85	10.4	000 or 3/0
250	1	120	12.4	4.7/0
275	1	150	13.91	5.5/0
350	1	185	16.06	6.7/0
400	1	240	17.96	7.7/0

## Description of Symbols

Symbol	Description	Symbol	Description
	Sensitive zone in jaws for slim conductors in CAT III 1000V areas		Bluetooth
	Safety Category (pXX)		ATEX certified electrical equipment for explosive atmosphere
	GPS		GS mark is based on the German Product Safety Act (pXX)
	Lifetime Warranty on most tools and selected instruments (pXX)		Relative humidity
	Sound level		True RMS (pXX)
	Temperature		Certification mark for individual products tested at 1000V (xx)
	Measures basic Ohms Law of Voltage Resistance and Current		Wi-Fi

## Instruments

CODE	DESCRIPTION	PAGE NO.
C4031601	Telescopic Link Stick	49
CAT4PLUS	Cable and Pipe Locator	54
CBSPK	Circuit Buddy Safety Probe Kit	69
CBTL	Circuit Buddy 6 to 50 Volt Test Light	69
CSH230	Link Stick 9m (30ft)	49
DUSPOLA	Analogue Voltage Line Plus	47
DUSPOLE	Expert Voltage Line	48
HT4005N	AC Standard Clamp	62
HVD	High Voltage Detector	52
LPC	Live Plug Connector	53
MACROG3	Compliance Tester	59
RD7100	Cable Route Tracer	54
T02AS	Universal - Test Leads	55
T10020C	1000V Hand Crank	33
T1105	Analogue Earth Resistance Tester	28
T111	Non-contact Thermometer	78
T1120	Digital Earth Resistance Tester	28
T1126	PSC Loop/Network Analyser	37
T1132	1000V Analogue Insulation Tester	31
T1133HVD25E	High Voltage Tester	51
T1151	1000V Digital Insulation Tester	32
T1151OLED	1000V Digital Insulation Tester OLED	32
T123	Process Calibrator	68
T1300H	Electronic DMM	7
T151	Non-Contact Thermometer	79
T175HP	Proximity Detector	48
T180	Tone and Probe Kit	44
T1800	1000V Analogue Insulation Tester	31
T1805	Analogue Earth Resistance Tester	27
T1812	ECLB Polarity Tester	40
T1820	Digital Earth Resistance Tester	28
T1825	PSC Loop Tester	37
T1826	PSC Loop Tester/Network Analyser	37
T1832	1000V Analogue Insulation Tester	31
T185	LAN Tester	70
T1851	1000V Digital Insulation Tester	32
T2000	Earth Resistance Clamp	24
T223	100A AC/DC - Digital Clamp Meter	21
T2238	Digital Tachometer	71
T235H	Electrician's DMM	8
T2608	2000A AC - Digital Clamp Meter	23
T260D	1000A AC - Digital Clamp Meter	19
T3004	Humidity / Temperature	76
T306	Non-Contact Thermometer	79
T325	Sound Level	76
T4137	Digital Milliohm Meter	41
T416	Earth Resistance and Resistivity	27
T419	Compliance Tester	59
T4201	Anemometer	77
T45200/T45000	Neon Screwdrivers	44
T48	Electronic DMM	8
T500K	Professional Thermometer	77
T5012	Carcheck	70
T502KJ	Professional Thermometer	78
T5050C	Hand Crank 5000V	33
T60	Compliance Tester	59
T6236	Digital Tachometer	71
T630	Digital Luxmeter	76
T685	Non Contact Thermometer	79
T70	Phase Sequence Indicator and Voltage Detector	44
T77N	AC Earth Leakage	20
T78	3-Phase Power Analyser and Recorder	61
T8000	Anemometer/Hygro/Lux/Temp	77
T8040LEAD	Universal - Test Leads	55
T8051	Process Calibrator	68
T8056	1000A AC/DC - Digital Clamp Meter	22
T820	DIY DMM	7
T8202	Vibration Tester	71

## Instruments

T8209	Multipurpose 5-in-1DMM	14
T824	3-Phase Power Analyser and Recorder	61
T835	DIY DMM	7
T855	3 Phase Rotation Indicator	42
T860	3 Phase and Motor Rotation Indicator	43
T887	3 Phase Rotation LCD Indicator	43
T890	3 Phase Detector	42
T98	1000A AC - Digital Clamp Meter	18
TAL1825	Accessory - Test Leads	56
TAL24	Universal - Test Leads	55
TAL25	Universal - Test Leads	55
TAL30ARBK	Silicone - Test Leads	56
TAL30CRBK	Accessory - Test Leads	56
TAL35RBK	Silicone - Test Leads	55
TAL36	Wide grip alligator clips	57
TAL36L	Wide grip alligator clips	57
TAL38CRBK	Accessory - Test Leads	56
TAL39RBK	Silicone - Test Leads	56
TAL58	Test Lead	57
TALTBM	Silicone - Test Leads	55
TALTIN	Test Leads	56
TBM061	400A AC/DC - Digital Clamp Meter	21
TBM062	400A AC/DC - Digital Clamp Meter	21
TBM072	600A AC AMP TIP Jaws	17
TBM076	600A AC AMP TIP Jaws	18
TBM079	600A AC/DC AMP TIP Jaws	22
TBM086	1000A AC AMP TIP Jaws	18
TBM089	1000A AC/DC AMP Tip Jaws	23
TBM116	1000A AC - Digital Clamp Meter	19
TBM118	2000A AC - Digital Clamp Meter	19
TBM135	1000A - Digital Clamp Meter	20
TBM157	1000A - Digital Clamp Meter	24
TBM162	1000A AC/DC - Digital Clamp Meter	22
TBM175D	Amtip™ Clamp Meter	17
TBM195	1000A AC/DC - Digital Clamp Meter	23
TBM197	2000A AC/DC - Digital Clamp Meter	24
TBM239R	Digital Clamp Meter	10
TBM252	Electronic General Purpose DMM	9
TBM27	Cord-size DMM	13
TBM3030	600A AC - Digital Clamp Meter	17
TBM319	Automotive Tester	13
TBM525	Data Logger DMM	10
TBM805	General Purpose DMM	8
TBM807	Electricians DMM	9
TBM811	General Purpose DMM	11
TBM811XEX	Intrinsic Safe DMM	12
TBM812	General Purpose DMM	11
TBM812XEX	Intrinsic Safe DMM	12
TBM829	Professional DMM	10
TBM869	Professional DMM	9
TBM878	Insulation/Combination DMM	13
TBT69	Industrial Voltage Tester	47
TBU	Software	14
TCTCDK	Compact Digital Compliance Kit	25
TCTDT	Digital Compliance Kit	25
TCTRP	Analogue Compliance Kit	25
TCV6	Voltage Tester	48
TDDGT	7 Day Digital Geyser Timer	72
TDDT7	7 Day Digital Timer	72
TDT7	Digital Timer	73
TEARTHKIT	Accessory- Test Leads	57
TEL11	ELCB Phase Rotation Tester	41
TEL11OLED	ELCB Phase Rotation Tester	41
TEL1TLB	ELCB /Polarity Socket Tester	42
TEL28	Industrial ELCB	39
TEL2SC	ELCB/Polarity	39
TELE10L	Industrial ELCB	40
TELEWR50F	Brass Banana Plug	57
TF3000	3000A Clamp Meter	20
TFLEX	Accessories - Power Analyser	62



## Instruments

TGTLC	Geyser Timer Load Controller	72
TG301	Thermal Imager	81
THT45	Thermal Imager	81
THT60	Thermal Imager with Digital Camera	82
THS25F	Telescopic Link Sticks	50
THS30F	Telescopic Link Sticks	50
THVD	High Voltage Detector	52
TIMP57	Line Loop Adaptor 400KA	39
TIN4D	Digital Insulation Tester 5KV	33
TIN5D	Digital Insulation Tester 10KV	34
TIN6A	Analogue Insulation Tester 10KV	34
TIN6D	Digital Insulation Tester 10KV	34
TIN7D	Digital Insulation Tester 10KV	35
TIN7DOLED	Digital Insulation Tester OLED 10KV	35
TIN8D	Digital Insulation Tester 15KV	35
TIR9PEN	Infrared Temperature Meter	78
TKIT800	Accessory - 5 Alligator Clips	62
TKPS54BK /TKPS54RD	Accessory - Twin Pointed Gripping Jaws	57
TLVD15	Non-contact Voltage Detection	45
TLVD17	Non-contact Voltage Detection	46
TLVD18	Volt-Finger Detector	46
TMDT2	24 Hour Mechanical Din Rail	73
TMT2	24 Hour Mechanical 3 Pin Socket	73
TP01	Bead Probe	75
TP02A	General Purpose Liquid Probe	75
TP04	Surface Contact Probe	75
TP04L	Surface Contact Probe	75
TPC7/11/22/33/44K	High Voltage Phase Comparators	50
TPK80	Thermal Imager	82
TPK160	Thermal Imager	82
TPQA820	3-Phase without Neutral	61
TS500	Non-Contact Voltage Protector	45
TSP1A	Surge Plug	45
TSP1AF	Surge Plug	45
VSCAN	Cable Avoidance Detector	53
VSCANM	Cable Avoidance Detector	53
VLOCPRO2	Cable Router Tracer	54
VTT25F	Telescopic Hot Stick (25ft)	49
VTT30F	Telescopic Hot Stick (30ft)	49
WIBRE1000	1000V CAT IV Voltage Line Tester	47
WIBRETEST	Industrial Voltage Line Tester	46
WPC1000	High Voltage Phase Tester	51
WPC3000	High Voltage Phase Tester	51
PVCHECK/ PVCHECK PRO	Photovoltaic Systems	67
SOLAR300N	Photovoltaic Systems	67
SOLAR02	Solar Remote Unit	67
IV500	Photovoltaic Systems	66
SOLARIV	Photovoltaic Systems	66
PT300N	PVCHECK PRO	67
HP30C2	Accessory - Photovoltaic	62
HP30D1	Accessory - Photovoltaic	62
HT4005K	Accessory - Photovoltaic	62

Tools

CODE	DESCRIPTION	PAGE NO.
218	Bahco Junior Hacksaw	117
226	Bahco Hacksaw	117
306	DIY Bahco Hacksaw	117
45092	Stripmaster	115
45120	T-Type® Wire Stripper and Cutter	115
45121	T-Type® Wire Stripper and Cutter	115
8325	Joint Pliers	112
95720	Electronic Screwdriver Set	121
ADP630HE	Die Adaptor	107
AK15	Lobster Crimper	101
AK19	Lobster Crimper	101
ASA486	Modular Connector Crimper	98
ASS103	Cable Stripper	115
AW100	Adjustable Spanner 100mm	123
AW150	Adjustable Spanner 150mm	123
AW200	Adjustable Spanner 200mm	123
AW250	Adjustable Spanner 250mm	123
AW300	Adjustable Spanner 300mm	123
BHD5	5 Piece Heavy Duty Blades	119
BOWCRIMPT	Indent Crimper	102
CC08	Cable Cutter	109
CC100	Cable cutter	109
CC22	Cable Cutter	109
CC250	Cable Cutter	109
CC38	Cable Cutter	109
CC500	Cable Cutter	110
CC60	Cable Cutter	109
CCMP	Multi-Crimp	99
CLI	Chalk Line Dispenser	124
CLB	Chalk Line Powder	124
CLR	Chalk Line Powder	124
CLW	Chalk Line Powder	124
CP20	Chassis Punch 20mm	119
CP22	Chassis Punch 22mm	119
CP25	Chassis Punch 25mm	119
CP32	Chassis Punch 32mm	119
CP40	Chassis Punch 40mm	119
CP50	Chassis Punch 50mm	119
EBN	Bent Nose Cutter	113
ECONOKIT	22 Piece Economy Electricians Kit	88
ECOSET	1000V Insulated Screwdriver Set	122
ECO375	1000V Insulated Screwdriver	122
ECP	Combination Plier	113
EDC	Diagonal Cutter	113
EEC	End Cutter	113
EK50ML	Electric Terminal Crimper	99
ELBKBP	20 Piece Budget Backpack and Tool Kit	86
ELECBP	32 Piece Backpack and Tool Kit	85
ELECKT	16 Piece Electrical Tool Kit	86
ELECMINI	14 Piece Tool KIT	90
ELITK	25 Piece Electrical Industrial Tool Kit	87
ELN	Long Nose Cutter	113
ENG375	Un-Insulated Screwdrivers	121
ENG575	Un-Insulated Screwdrivers	121
ENG5100	Un-Insulated Screwdrivers	121
ENG6100	Un-Insulated Screwdrivers	121
ENGP1	Un-Insulated Screwdrivers	121
ENGP2	Un-Insulated Screwdrivers	121
ENGSET	Un-Insulated Screwdriver Set	121
EP30MS	Electric Hydraulic Pump	107
ES6	Electronic Screwdriver Set	121
EVO7	Nylon Cable Tie Tensioning Tool	139
EVO9	Nylon Cable Tie Tensioning Tool	139
FH700FP	Hydraulic Foot Pump	107
FT30	Fish Tape 30m	124
FT60	Fish Tape 60m	124
GLUEMATIC3002	Hot Melt Glue Applicator	136
GLUEPRO400	Hot Melt Glue Applicator	136
H011	Mini Deluxe Hacksaw	117

Tools

H015	Junior Hacksaw	118
H100A	Heavy Duty Deluxe Hacksaw	118
H10M	Tape Measure 10M	125
H300T	Tubular Hacksaw	118
H2230	Fish Tape Nylon 30m	124
H3M	Tape Measure 3m	125
H5M	Tape Measure 5m	125
H8M	Tape Measure 8m	125
HAMB300	Fibreglass Pein Hammer	126
HAMB350	Fibreglass Ball Pein Hammer	126
HAMCB11	Fibreglass Club Hammer	126
HAMCWA	Steel Claw Hammer	126
HAMCWF	Fibreglass Claw Hammer	126
HCP180	Electrician's Pliers 1000V	114
HCP200	Electrician's Pliers 1000V	114
HCP200H	Electrician's Pliers 1000V	114
HD06120AU	Hex Crimper (Super Range)	101
HD0650AU	Hex Crimper (Super Range)	101
HD16L	Medium Duty Crimper	100
HD22L	Medium Duty Crimper	100
HD25150AU	Hex Crimper (Super Range)	102
HD25X	Medium Duty Crimper	100
HDC160	Diagonal Cutter 1000V Heavy Duty	114
HDC160H	Diagonal Cutter 1000V Heavy Duty	114
HDC180	Diagonal Cutter 1000V Heavy Duty	114
HDC180H	Diagonal Cutter 1000V Heavy Duty	114
HDC205H	Diagonal Cutter 1000V Heavy Duty	114
HDRJ45N	Modular Connector Crimper	98
HEADLIGHT	LED Headlight	140
HEADLIGHTPRO	Headlight	140
HEXSET	Un-Insulated Screwdriver Set	122
HEX0945	Un-Insulated Screwdriver	122
HEX1790	1000V Un-insulated Screwdriver	122
HG2120E	Professional Steinel Heat Gun	133
HH700HP	Hydraulic Hand Pump	107
HL1620S	DIY Steinel Heat Gun	133
HL1920E	DIY Steinel Heat Gun	133
HLN160	Long Nose Pliers 1000V	114
HLN200	Long Nose Pliers 1000V	114
HLSTICK	Hot Air Tool	135
HS18	Holesaw: 18mm	119
HS20	Holesaw: 20mm	119
HS2004	DIY Crimper (Budget)	95
HS21	Holesaw: 21mm	119
HS25	Holesaw: 25mm	119
HS32	Holesaw: 32mm	119
HS40	Holesaw: 40mm	119
HS50	Holesaw: 50mm	119
HS63	Holesaw: 63mm	119
HS75	Holesaw: 75mm	119
HSBLD18E	Hacksaw Blade	118
HSBLD18HS	Hacksaw Blade	118
HSBLD18U	Hacksaw Blade	118
HSBLD24E	Hacksaw Blade	118
HSBLD24HS	Hacksaw Blade	118
HSBLD24U	Hacksaw Blade	118
HSBLD32E	Hacksaw Blade	118
HSBLD32HS	Hacksaw Blade	118
HSBLD32U	Hacksaw Blade	118
HT06120	Hex Crimper (Budget)	101
HT0650	Hex Crimper (Budget)	101
HT16UT	Light Duty Crimper	100
HT25UT	Medium Duty Crimper	100
HT338	Stainless Steel Tensioning Tool	139
HTJ30	Cable Cutter	111
HTJ35	Core Cutter	111
HTJ76	Cable Cutter	111
HTS250	Aviation Tin Snips	124
HUK1	Universal Key	123
HY360RP	360° Rotational Punch Kit	106

## Tools

HYCC0755	Hydraulic Cutting Head	108
HYCC065HE	Hydraulic Cutting Head	108
HYCC096	Hydraulic Armoured Cable Cutter	108
HYCC85	Hydraulic Cable Cutter	108
HYCC85HE	Hydraulic Cutting Head	108
HYCP185	Hand Hydraulic Crimper	103
HYCP185KT	Hand Hydraulic Crimper Kit	103
HYCP240	Hand Hydraulic Crimper	103
HYCP240KT	Hand Hydraulic Crimper Kit	103
HYCP400	Hand Hydraulic Crimper	103
HYCP400HE	Hydraulic Crimp Head	107
HYCP400KT	Hand Hydraulic Crimper Kit	103
HYCP630HE	Hydraulic Crimp Head	107
HYLEC32	Battery Operated Crimper	104
HYLEC6	Battery Operated Indent Crimper Kit	104
HYPH5216D	Hydraulic Punch: 16mm	105
HYPH5222D	Hydraulic Punch: 22mm	105
HYPH5225D	Hydraulic Punch: 25mm	105
HYPH5232D	Hydraulic Punch: 32mm	105
HYPH5240D	Hydraulic Punch: 40mm	105
HYPH5250D	Hydraulic Punch: 50mm	105
HYPH5220D	Hydraulic Punch: 20mm	105
HYPN052M	Hydraulic Punch Drive Kit	105
HYPNST	Hydraulic Punch Drive Kit with Pump	105
HYTP	Rotary Punch Kit	106
HYUC6	Hand Hydraulic Indent Crimper Kit	105
HYUC6HE	Hydraulic Indent Crimping Head	108
INSSET	1000V Insulated Screwdriver Set	122
INS7525	1000V Insulated Screwdriver	122
INS1040	1000V Insulated Screwdriver	122
INS1255	1000V Insulated Screwdriver	122
INS1565	1000V Insulated Screwdriver	122
INSP1	1000V Insulated Screwdriver	122
INSP2	1000V Insulated Screwdriver	122
INS1780	1000V Insulated Screwdriver	122
INSPO	1000V Insulated Screwdriver	122
INSPV1	1000V Insulated Screwdriver	122
K05B	Hex Crimper (Klauke)	102
K06B	Hex Crimper (Klauke)	102
K240KT	Battery Operated Hydraulic Crimper	104
KST2000A	Deluxe Ratchet Crimping Tool	95
KST2000B	Ratchet Crimping Tool - Twingrip	95
L100250	Spirit Level	125
L100450	Spirit Level	125
L100800	Spirit Level	125
LCP150	Electricians Pliers (Budget)	112
LCP180	Electricians Pliers (Budget)	112
LCP200	Electricians Pliers (Budget)	112
LDC125	Diagonal Cutter (Budget)	112
LDC150	Diagonal Cutter (Budget)	112
LDC180	Diagonal Cutter (Budget)	112
LDC200	Diagonal Cutter (Budget)	112
LEDTORCH	Waterproof Led Torch	140
LGJ250	Joint Pliers (Budget)	112
LGJ300	Joint Pliers (Budget)	112
LLN150	Long Nose Pliers (Budget)	112
LLN200	Long Nose Pliers (Budget)	112
LY2001	DIY Crimper (Budget)	95
MHT3	Magnetic Tape Measure: 3m	125
MHT5	Magnetic Tape Measure: 5m	125
MHT8	Magnetic Tape Measure: 8m	125
MINIKT	13 Piece Compact Electrician's Tool kit	91
MK10TEN	Nylon Cable Tie Tensioning Tool	138
MK3TEN	Nylon Cable Tie Tensioning Tool	138
MK9SST	Stainless Steel Tensioning Tool	139
MK20	Nylon Cable Tie Tensioning Tool	138
MTOOL	16-in-1 Multi Tool	116
NEO2	Hot Melt Glue Applicator	136
NOZREF	Nozzle Reflector	134

## Tools

NOZREF10	Nozzle Solder Reflector 10mm	134
NOZRED9	Nozzle Reducer 9mm	134
NOZRED14	Nozzle Reducer 14mm	134
NOZSUR50	Nozzle Surface 50mm	134
NOZSUR75	Nozzle Shaping Surface 75mm	134
NOZWIDE14	Nozzle Welding Wide Slit 14mm	134
O1003	10 Piece Allen Key Set	124
O1604LM	7 Piece Allen Key Set	124
O9FA	9 Piece Allen Key Set	124
P100A	Heavy Duty Deluxe Hacksaw	118
PC230W	1000V Electrical Plier and Crimper	114
PCS	Tool Bag	92
PK1000V	17 Piece Electrical Tool Kit 1000V	88
PKEL	16 Piece Budget Tool Kit	90
PKELL	20 Piece Budget Electronic Tool Kit	89
PKELS	20 Piece Electronic Tool Kit	89
PROKT	16 Piece Electrician's Tool Kit	86
PTS4	Wire Stripper and Cutter	115
PVBP	Solar Backpack Kit	85
PVCT46	PV Crimper (Solar)	99
PVCT46B	PV Crimper (Solar)	99
PVST46	PV Stripping Tool	115
R1STUD	Hydraulic Punch Spare	105
RCC325PH	Core Cutter	111
RCC500	Core Cutter	111
RCS0425	Rotary Stripper	116
RJ86	Modular Connector Crimper	98
RKES	15 Piece Roll-Up Electrical Kit	91
RSSTUD	Hydraulic Punch Spare	105
S25	PVC Pipe Cutter	111
SCC200	Cable Cutter	110
SCC60	Cable Cutter	110
SDC160	Diagonal Cutter (Super Range)	113
SDC180	Super Range Diagonal Cutter	113
SDC200	Super Range Diagonal Cutter	113
SEP160	Electrician's Pliers (Super Range)	113
SEP180	Electrician's Pliers (Super Range)	113
SEP200	Electrician's Pliers (Super Range)	113
SLN160	Long Nose Pliers (Super Range)	113
SLN200	Long Nose Pliers (Super Range)	113
SLNS200	Long Nose Pliers (Super Range)	113
SOLDER	Solder Wire	132
SOLDERIRON	Solder Iron	132
SOLDERSUCK	Solder Sucker	132
SOLDERGAS	Clipper Butane Gas	132
SP115N	Cable Cutter (Budget)	112
SPAN12	12 Piece Spanner Set	123
SVN160	Electrician's Wire Stripper (Super Range)	113
SWSET	Socket Wrench Set	123
SW8	Socket Wrench	123
SW10	Socket Wrench	123
T16	Uninsulated Terminal Crimper	99
TCT20	Tungsten Holesaw: 20mm	119
TCT22	Tungsten Holesaw: 22mm	119
TCT25	Tungsten Holesaw: 25mm	119
TCT32	Tungsten Holesaw: 32mm	119
TCT40	Tungsten Holesaw: 40mm	119
TCT51	Tungsten Holesaw: 51mm	119
TCT64	Tungsten Holesaw: 64mm	119
TCT73	Tungsten Holesaw: 73mm	119
TCT76	Tungsten Holesaw: 76mm	119
TCT83	Tungsten Holesaw: 83mm	119
TCT8KT	8 Piece Tungsten Holesaw Kit	119
TCTBITS	Optional Spare Bits	119
TG007	Plastic Frame Tensioning Tool	138
TG008	Steel Frame Tensioning Tool	138
TKEL	22 Piece Large Electrical Tool Kit	87
TOOLBAGBP	Backpack	91
TOOLBAGL	Tool Bag	91

## Tools

TOOLBAGM	Tool Bag	92
TOOLBAGP	Tool Bag	92
TOOLBAGS	Tool Bag	92
TMULTCSE	Multimeter Carry Pouch	92
TOOLBOX	Toolbox	125
TORCH1000	LED Waterproof Torch	140
TP100	Soldering Iron	131
TP100K	Soldering Iron Kit	131
TP200	Soldering Iron	131
TP200K	Soldering Iron	131
TP720K	Soldering Iron Kit	132
TSF14	Ring Angle Torch	140
TSF4	Water Resistant Torch	140
VG175	Vice Grip: 175mm	123
VG250	Vice Grip: 250mm	123
WAK1	Retractable Utility Knife and Stripper	116
WAK2	Manual Retractable Utility Knife	116
WAK3	Manual Retractable Utility Knife	116
WAK9	Snap-off Pro	116
WAK3BLD	Snap-off Knife Blade	117
WAK9BLD	Snap-off Knife Blade	117
WARB1	Arbour	119
WARB2	Arbour	119
WHS13KT	13 Piece Bi-Metal Holesaw Kit	120
WHS15KT	15 Piece Bi-Metal Holesaw Kit	120
WHS16	Bi-Metal Holesaw: 16mm	119
WHS20	Bi-Metal Holesaw: 20mm	119
WHS22	Bi-Metal Holesaw: 22mm	119
WHS25	Bi-Metal Holesaw: 25mm	119
WHS32	Bi-Metal Holesaw: 32mm	119
WHS38	Bi-Metal Holesaw: 38mm	119
WHS40	Bi-Metal Holesaw: 40mm	119
WHS51	Bi-Metal Holesaw: 51mm	119
WHS60	Bi-Metal Holesaw: 60mm	119
WHS64	Bi-Metal Holesaw: 64mm	119
WHS70	Bi-Metal Holesaw: 70mm	119
WHS73	Bi-Metal Holesaw: 73mm	119
WHS76	Bi-Metal Holesaw: 76mm	119
WHS83	Bi-Metal Holesaw: 83mm	119
WHS95	Bi-Metal Holesaw: 95mm	119
WHS105	Bi-Metal Holesaw: 95mm	119
WHS111	Bi-Metal Holesaw: 95mm	119
WHS9KT	9 Piece Bi-Metal Holesaw Kit	120
YAC17	Bootlace Ferrule Crimper	96
YAC19	Angle Griptite Crimper	97
YAC3	Coax Crimper	97
YAC5	Bootlace Ferrule Crimper	95
YAC6	Bootlace Ferrule Crimper	96
YAC8	Bootlace Ferrule Crimper	96
YAC9	Bootlace Ferrule Crimper	96
YCI607A	Wire Stripper	115
YCI607B	Wire Stripper	115
YYT1	Pre insulated Terminal Crimper	95
YYT11	Crimper Tab (Griptide) Terminals	97
YYT15	Close End Connector Crimper	97
YYT21	Bootlace Ferrule Crimper	97
YYT22	Bootlace Ferrule Crimper	97
YYT7	Pre insulated Terminal Crimper	95
YYT8	Uninsulated Terminal Crimper	98
YYT9	Uninsulated Terminal Crimper	98
YYTB2	Compact Uninsulated Terminal Crimper	98
YYTB3	Compact Uninsulated Terminal Crimper	98
YYTB4	Compact Bootlace Ferrule Crimper	96
YYTB6	Compact Bootlace Ferrule Crimper	96

## Tools

**1000V DOUBLE INSULATED TOOLS**

HT100205	1000V Insulated Pliers	128
HT104200	1000V Insulated Long Nose Pliers	128
HT112180	1000V Insulated Diagonal Pliers	128
HT116240	1000V Insulated Water Pump Pliers	128
HT121205	1000V Insulated Cable Cutter	129
HT125240	1000V Insulated Cable Cutter	129
HT20010	1000V Open-Ended Spanner	127
HT20013	1000V Open-Ended Spanner	127
HT20016	1000V Open-Ended Spanner	127
HT20017	1000V Open-Ended Spanner	127
HT20019	1000V Open-Ended Spanner	127
HT21013	1000V Insulated Ring Spanner	127
HT21014	1000V Insulated Ring Spanner	127
HT21017	1000V Insulated Ring Spanner	127
HT21019	1000V Insulated Ring Spanner	127
HT21022	1000V Insulated Ring Spanner	127
HT280260	Reversible Ratchet	128
HT285125	1000V Extension Bar	127
HT285250	1000V Extension Bar	127
HT31613	6-Point Sockets	128
HT31617	6-Point Sockets	128
HT40010	1000V Insulated Screwdriver	127
HT40055	1000V Insulated Screwdriver	127
HT40065	1000V Insulated Screwdriver	127
HT4101	1000V Insulated Cross Screwdriver	127
HT4102	1000V Insulated Cross Screwdriver	127
HT4103	1000V Insulated Cross Screwdriver	127
HT52545	Cable Stripping Knife	129
HT53040	1000V Hooked Cable Knife	129
HT762250	1000V Insulated Adjustable Spanner	127
HT765250	1000V Insulated Mini Hacksaw	129
HT767450	1000V Insulated Hacksaw	129
HT90026	1000V Insulated 26 Piece Tool Kit	130
HT91615	1000V Insulated 15 Piece Tool Kit	130

**1. Proof of Claims**

A certificate signed by a manager or any director of THE COMPANY reflecting the amount owing by THE CUSTOMER to THE COMPANY, in respect of the credit facilities granted to THE CUSTOMER relating to THE CUSTOMER'S dealings with THE COMPANY, and of the fact that such amount is due, owing and unpaid shall be prima facie proof of the effects therein stated for the purpose of any action (whether by way of provisional sentence or otherwise), proof of debt on insolvency or for any purpose whatsoever where the amount of such claims is required to be established, and it shall rest with THE CUSTOMER to prove that such amount is not owing and/or due and unpaid.

**2. Consent to jurisdiction**

Notwithstanding the amount which may at any time be owing by THE CUSTOMER to THE COMPANY, the parties do hereby consent, in terms of Section 45 of the Magistrates Court Act (No 32 of 1944 as amended), to the Jurisdiction of the Magistrate's Court for the determination of any action or proceeding which may be brought by THE COMPANY against THE CUSTOMER arising out of any transaction between the parties, it being recorded that THE COMPANY shall be entitled, but not obliged, to bring any action or proceeding in the said court.

**3. Defaulting in payment**

In the event of THE CUSTOMER defaulting in making payment of any amount that has become due and owing, then the full balance outstanding (whether due or not) will immediately become due and payable without notice to THE CUSTOMER.

**4. Change of address**

THE CUSTOMER undertakes to notify THE COMPANY forthwith in writing of any change of address.

**5. Objections to statement**

If THE CUSTOMER should fail to object to any item appearing on THE COMPANY'S statement of account within fourteen days of date of the dispatch of the statements the accounts shall be deemed to be in order.

**6. Change of ownership**

THE CUSTOMER undertakes to notify THE COMPANY, in writing, within seven days of any change in Ownership of THE CUSTOMER'S business, or should THE CUSTOMER be a company, of its share transactions whereby the majority shareholding is affected, failing which notice the entire balance owing, whether due or not, will immediately be deemed to be due and payable by THE CUSTOMER. In addition to the foregoing, THE CUSTOMER acknowledges that immediately upon any change of Ownership in THE CUSTOMER any outstanding amount whether due or not shall be deemed to be forthwith payable by THE CUSTOMER to THE COMPANY.

**7. Reservation of ownership**

Until such time as THE CUSTOMER has paid the purchase price in full in respect of any purchase of goods, the ownership in and to all such goods shall remain vested in THE COMPANY. THE COMPANY shall, in its sole discretion, without notice to THE CUSTOMER, be entitled to take possession of any such goods which have not been paid for and in respect of which payment is overdue, in which event THE CUSTOMER shall be entitled to a credit in respect of the goods so returned being the price at which the goods are sold or the value thereof as determined by THE COMPANY. THE CUSTOMER hereby waives any right it may have for a spoliation order against THE COMPANY in the event that THE COMPANY takes possession of any goods.

**8. Valid orders**

In the event of any order being given to THE COMPANY on an order form reflecting THE CUSTOMER'S name as the entity from which the order emanates, such order shall be deemed to have emanated from THE CUSTOMER, notwithstanding the fact that such order may have been given or signed by a person not authorised by THE CUSTOMER and such order will be deemed to constitute valid delivery. It is further the sole responsibility of THE CUSTOMER to determine that goods ordered are suitable for the purposes of the intended use.

**9. Non-waiver of rights**

Any condonation of any breach of any of the provisions hereof or other act or relaxation, indulgence or grace on the part of THE COMPANY shall not in any way operate as or be deemed to be a waiver by THE COMPANY of any rights under this contract, or be construed as a novation thereof.

**10. Payment to COMPANY**

THE COMPANY does not appoint the Post Office as its agents for payments by post. All payments shall be made to THE COMPANY'S place of business from where the goods were ordered. In the event of any payments being mislaid or lost in the post, THE CUSTOMER shall still be liable to THE COMPANY for payment.

**11. Credit terms**

The credit terms are, unless amended in writing by a director/manager of THE COMPANY, 30 (thirty) days nett, where such days are calculated from the date of statement. Settlement is effected only on receipt of cash or due honour of cheque or similar payment instrument. Any credit facilities granted to THE CUSTOMER by THE COMPANY is entirely at the discretion of THE COMPANY, and may be withdrawn at any time.

**12. Interest on overdue accounts**

THE COMPANY shall be entitled to charge the CUSTOMER interest at the rate of 2% per month in terms of the National Credit Act, provided however, that nothing contained herein shall be interpreted as obliging THE COMPANY to afford THE CUSTOMER any such indulgence to effect payment after due date.

**13. Consent to sharing information**

THE CUSTOMER consents to THE COMPANY sharing information on his account with THE COMPANY, with other credit grantors and credit information agents. Information shared with such credit grantors and agents is used to make credit granting decisions, to prevent fraud and manage risk.

**14. Delivery**

14.1 THE CUSTOMER agrees that the signature of any agent, contractor, sub-contractor or employee of THE CUSTOMER on THE COMPANY'S official delivery note/invoice/waybill, or the delivery note of any authorised independent carrier will constitute delivery of the goods purchased.

14.2 Any delivery date stated on the order confirmation is approximate only. THE COMPANY shall not be bound by that date, but will make all reasonable efforts to deliver by that date.

14.3 Whilst THE COMPANY will endeavour to ensure that goods are delivered timeously, it shall not be responsible for any delays in the delivery of such goods, and THE CUSTOMER shall not be entitled to refuse acceptance of such late deliveries. THE COMPANY shall in any event not be liable to THE CUSTOMER, or to any third party, for any loss of whatsoever nature as a result of goods not being delivered timeously.

14.4 The risk in and to the goods shall pass from THE COMPANY to THE CUSTOMER on the date of delivery notwithstanding that ownership will not pass to THE CUSTOMER until full payment of the purchase price. Delivery shall be deemed to have taken place against signature of THE COMPANY'S delivery note, proof of posting if the goods are posted to THE CUSTOMER or delivery to the South African Transport Services or Road Carrier if the goods are railed or transported by THE COMPANY. The Post Office/South African Transport Services or Road Carrier shall act as the agent of THE CUSTOMER.

14.5 In the event of THE COMPANY acceding to any request by THE CUSTOMER to postpone delivery of the goods, or in the event of THE CUSTOMER failing to give THE COMPANY sufficient information to enable it to process any order, THE CUSTOMER will pay any costs and expenses thereby incurred by THE COMPANY.

14.6 THE CUSTOMER agrees that goods will be offloaded at the nearest accessible point on site. THE COMPANY shall not be held responsible for any damage to any goods delivered during the delivery process, arising from any cause whatsoever.

**15. Recovery of legal /collection costs**

Should THE COMPANY instruct its attorneys or collection agent to collect any overdue amounts, or to take any action against THE CUSTOMER in the implementation or protection of THE COMPANY'S rights, THE COMPANY shall be entitled to the recovery of all legal or collection costs arising there from, on the scale as between attorney, agent or collection agency and own client.

**16. Responsibility for losses / damages or delays**

THE COMPANY will not be in any way responsible for losses, damages or delays caused by or arising from a natural and unavoidable catastrophe or acts of the State's enemies, riots, lockouts, cessation of labour, transport delays, shortened hours of labour, accidents of any kind, insurrection, war, whether declared or not, the imposition of any trade boycotts or sanctions of trade restrictions by any government, authority, company or organisation or person or persons, whether within the Republic of South Africa or anywhere else, or any other cause or contingency whatsoever beyond the control of THE COMPANY, whether of the same kind (eiusdem generis) with the causes aforementioned or not.

**17. Jurisdiction of magistrate's court – irrespective of value**

THE CUSTOMER consents that at the option of THE COMPANY (who shall be entitled but not obliged hereunder) any proceedings against THE CUSTOMER may be brought by the Magistrate's Court, notwithstanding that the value of the claimable amount exceeds the jurisdiction of the Court.

**18. Severability of clauses**

Each clause of these conditions of sale is severable, the one from the other and if any one or more clauses are found to be invalid or unenforceable, that clause/clauses shall not affect the balance of these conditions of sale, which shall remain of full force and effect.